

1/35 German CMP Ford F15 Truck with 20mm Flak 30 gun mounted



contains 1 highly detailed and accurate model

164 resin parts, 2 clear resin lights
90+ PE parts, turned metal gun barrel
5 ammo boxes

+ plastic parts and wires needed for assembly
decals for 2 vehicles
glue and paints not included
suitable for average modellers
keep safety rules for work with resin
instructions and references on CD



No.35412

WWW.LZmodels.com

Made in EU

Keep safety rules when working with resin.

For safety reasons, and due to the complexity of construction, this kit is recommended only for advanced modellers.

The kit contains small parts, keep it out of the reach of children. Glue and paints not included

From Wikipedia:

The Canadian Military Pattern (CMP) truck was a class of military truck made in large numbers in Canada during World War II to British Army specifications for use in the armies of the British Commonwealth allies. CMP trucks were also sent to the Soviet Union following the Nazi invasion of Russia, as part of Canada's lend-lease program to the Allies. During the War CMP trucks saw service around the world in the North African Campaign, the Allied invasion of Sicily, the Italian Campaign, the Russian Front, the Burma Campaign, the Battle of the Philippines (1941-42), the liberation of Northwest Europe, and the Western Allied invasion of Germany. CMP trucks also saw service in post-war conflicts in Indonesia, French Indochina, and the Portuguese colonies in Africa.

The rise to power in Germany of Hitler and the Nazi party in 1933 led to discussions in the mid-1930s between the British War Office and the Canadian Army concerning the possible production of military vehicles in Canada. During the First World War Canadian land forces had participated as a corps in the British Army. In any future conflict it was assumed that Canadian forces would again be tightly integrated with those of the Mother Country, and so it would be essential that Canadian-manufactured equipment be compatible with British standards and specifications.

Early in 1937, the Ford Motor Company of Canada and General Motors of Canada Ltd were each invited by the Canadian Department of National Defence to produce a Canadianized prototype of a 15-hundredweight light infantry truck that had then been recently adopted by the British War Office[1]. By 1938 Canadian military authorities had shifted their interest to heavier 4x4 and 6x4 designs. In that year Ford and GM were invited to produce prototypes of a 6x4 medium artillery tractor derived from the British 6x4 Scammell Pioneer. By 1939, plans had been prepared for the mass production in Canada of a range of military vehicles based on fairly strict British specifications. These trucks were originally designated "Department of National Defence (DND) Pattern"; however, when production volumes increased and it became clear that the Canadian-built vehicles were to serve widely in the forces of other countries, the class of trucks was redesignated "Canadian Military Pattern (CMP)". At the outbreak of World War II, Canada's relatively large and modern automobile industry was shifted over to the production of military vehicles. While the Dunkirk evacuation in the spring of 1940 succeeded in rescuing close to 340,000 Allied soldiers who had been encircled by the invading German army, the British Expeditionary Force had been required to abandon most of its military vehicles in France. It then became an urgent need to replace those losses and to provide new vehicles to equip the rapidly expanding armed forces of the Commonwealth.

Canadian military truck production included both modified civilian designs as well as purely military designs based on the CMP specification, in roughly equal numbers. Truck production was focussed on a broad range of medium-capacity vehicles; Jeeps and trucks larger than 3 tons in capacity required by the Canadian Army were purchased from U.S. suppliers. Most CMP trucks were manufactured by the Chevrolet division of General Motors of Canada Ltd and by the Ford Motor Company of Canada. The Canadian subsidiaries of the two largest American vehicle manufacturers were able to rapidly ramp up their production because of an unusual degree of inter-company collaboration, the use of interchangeable parts, and because of the large amount of idle production capacity that was a lingering result of the Great Depression. A smaller number of CMP trucks were assembled from Canadian-made chassis and parts in Britain, Australia, New Zealand, South Africa (2600), India (9500) and Egypt. In Germany the facilities of GM subsidiary Opel and those of Ford-Werke AG were pressed into service to make military vehicles for the Nazi war effort. Following British convention, CMP trucks had right-hand drive even though most of them were built in Canada, which primarily used left-hand drive vehicles. The CMP specification

proved versatile, and it formed the basis of a wide variety of different truck types and armoured vehicles. In Australian service (almost always with the No. 13 cab) these vehicles were known as the "Chev Blitz" or the "Ford Blitz".

Just over 400,000 CMP trucks were manufactured in Canada, accounting for roughly half of the 815,729 military vehicles made in Canada during World War II. The most prevalent type was the 4x4 3-ton truck (including models C60S, C60L, F60S and F60L), with just over 209,000 vehicles made. In addition, roughly 9500 4x4 CMP chassis were made, mainly to be used to build armoured cars and other vehicles in Allied countries. CMP truck production in Canada exceeded the total military truck production of Nazi Germany. The British official history of the war argues that the production of soft-skinned trucks, including the CMP truck class, was Canada's most important contribution to the eventual Allied victory

Newly manufactured or modified war surplus CMP trucks were used after 1945 in several European armies (e.g., the Netherlands, Belgium, Denmark, Norway, Portugal, Spain) and around the world (e.g., South Africa, Argentina, Jordan, South Vietnam, Malaya). CMP trucks were adapted after the war for a variety of civilian roles including forestry, grain transport, fire-fighting trucks, and snowploughs.

The Ford-built CMP trucks had a 239 cu in (3.9 L), 95 bhp (70.8 kW) V8 engine, while most of the Chevrolet-built CMP trucks had a 215 cu in (3.5 L), 85 bhp (63.4 kW) straight-6 overhead-valve engine. An American-made 270 cu in (4.4 L) GMC straight-6 engine powered the C60X 3-ton truck.

The Ford and Chevrolet trucks shared a standard cab design, which evolved over the years of production. The first (designed at Ford by Sid Swallow), second and third cab designs were called No. 11, 12 and 13, respectively. The first two type were similar, main difference being two-part radiator grille in No.12 cab (its upper part was opened with a bonnet, which was known as the "Alligator cab"). The final No. 13 cab, an entirely Canadian design made from late 1941 until the end of the war, had the two flat panes of the windscreen angled slightly downward to minimize the glare from the sun and to avoid causing strong reflections that would be observable from aircraft. All of the CMP cab designs had a short, "cab forward" configuration that gave CMP trucks their distinctive pug-nosed profile. This design was required to meet the original British specifications for a compact truck design that would be more efficient to transport by ship. The specifications also demanded right-hand drive. Internally the cab had to accommodate the comparatively large North American engines and it was generally cramped. The standard cabs were then matched up with a variety of standard chassis, drive trains and body designs.

The production of CMP truck bodies in Canada was subcontracted out to smaller companies in Ontario and Manitoba, organized into the wartime Steel Body Manufacturers Association by the Department of Munitions and Supply. The wide variety of truck body designs included general service (GS), water tanker, fuel tanker, vehicle recovery (tow truck), dental clinic, mobile laundry, wireless house, machinery (machine shop), folding boat transport, and antitank gun portee.



A13 2x



A1

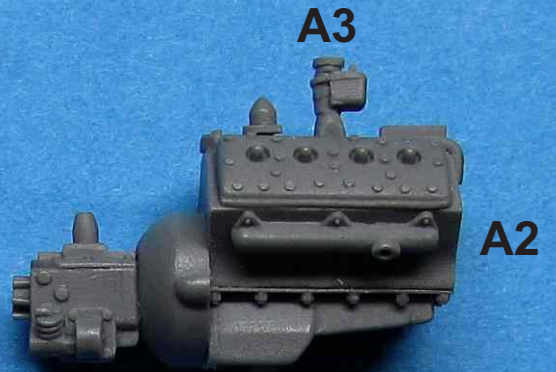

A3

A2



A14

2x

A4



A5



A6



A7



2x

A8



A9



A10



A11



A12

A12



Number of pieces in red if multiple

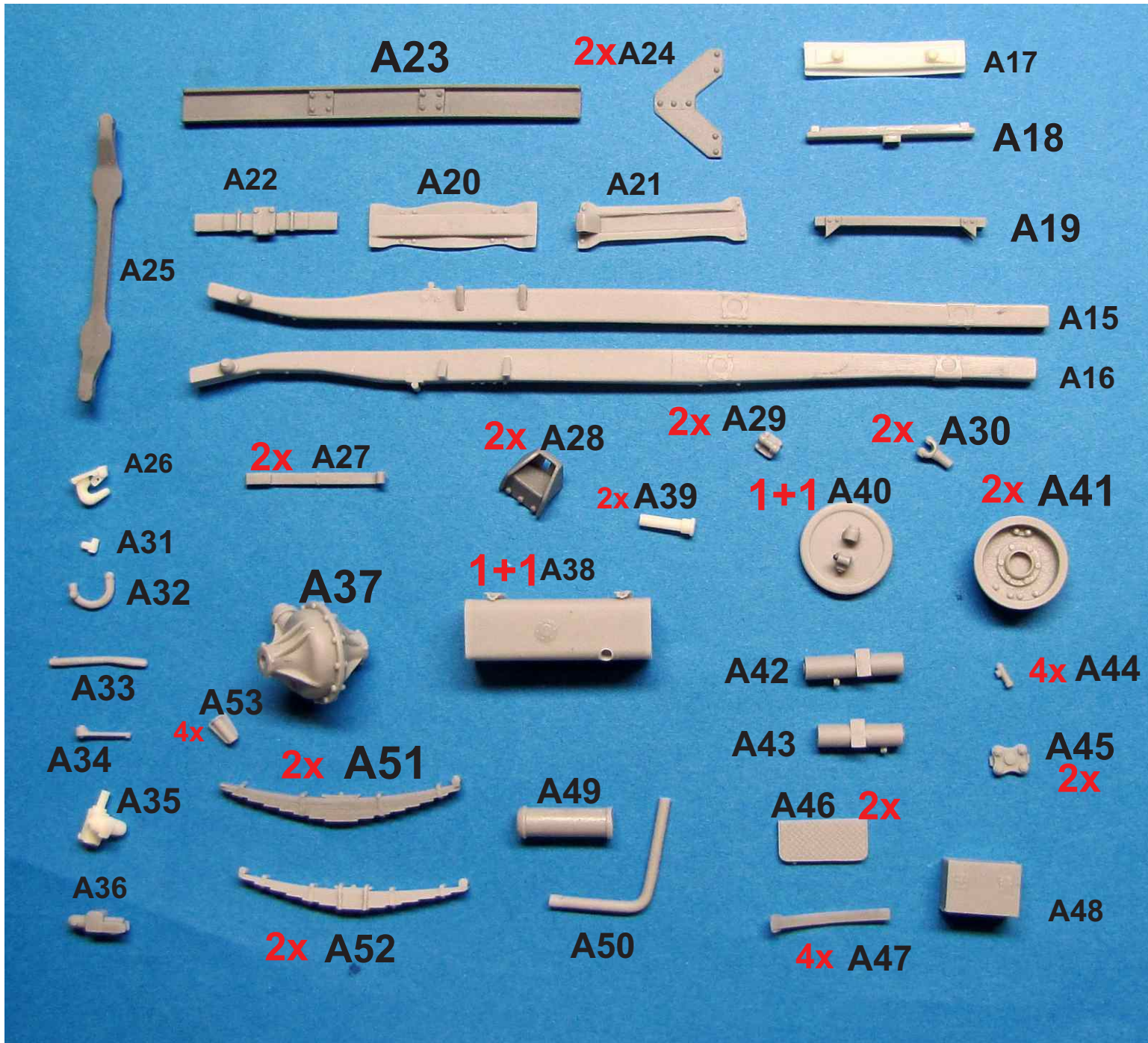

A88 - fuel filter

1+1 A54

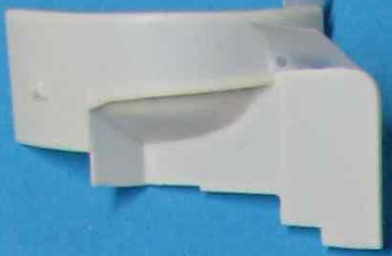

A55



A56



A57



A58



A59



A60



1+1 A61



2x A64



A65



4x A62



2x A68



A87



4x A63



A66



A70



A86



A71



A72



A69



A67



A73



A76

1+1



A74



A77



2x A85

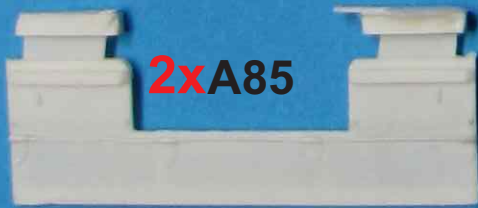

1+1 A75



A78



A84



2x A79

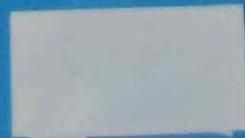

A83



2x A80



4x A81



2x A82



This kit is not difficult to build, and there are not many small parts and PE bits to deal with. The main thing is to keep the right angles where required. If some parts warp, they can be easily straightened with use of hot water or hair dryer. Many of the parts are very thin and pretty flexible to work with, and with a little bit of hot water they can be perfectly straightened or bent. I would recommend to dry-fit some parts before they are glued together. I will mention here any steps, where extra care has to be taken

Chassis assembly:

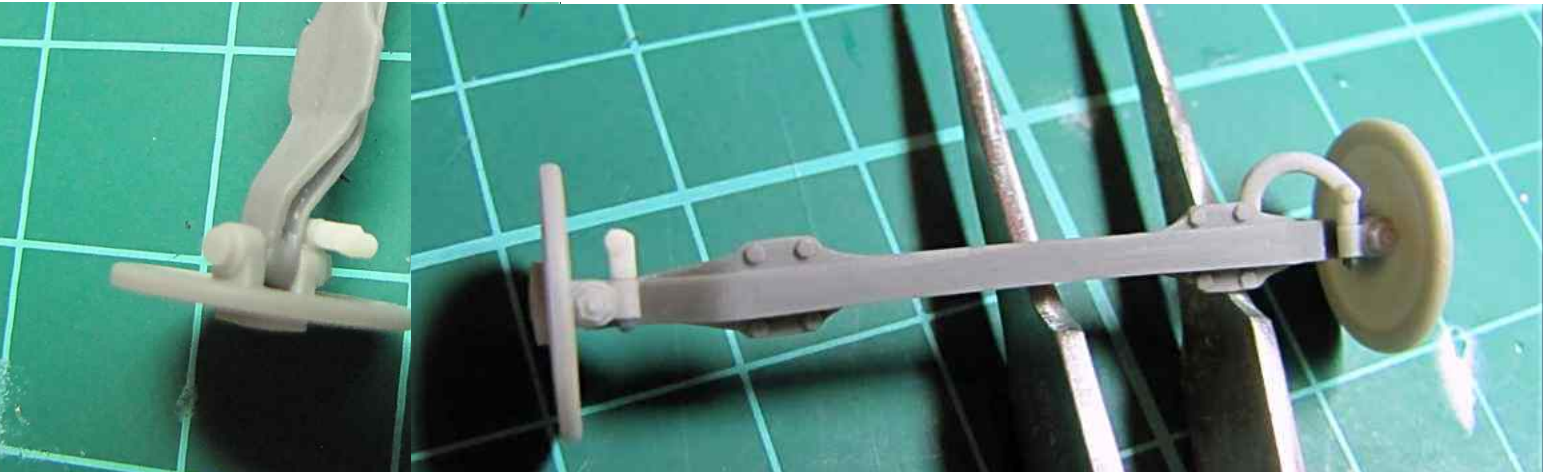
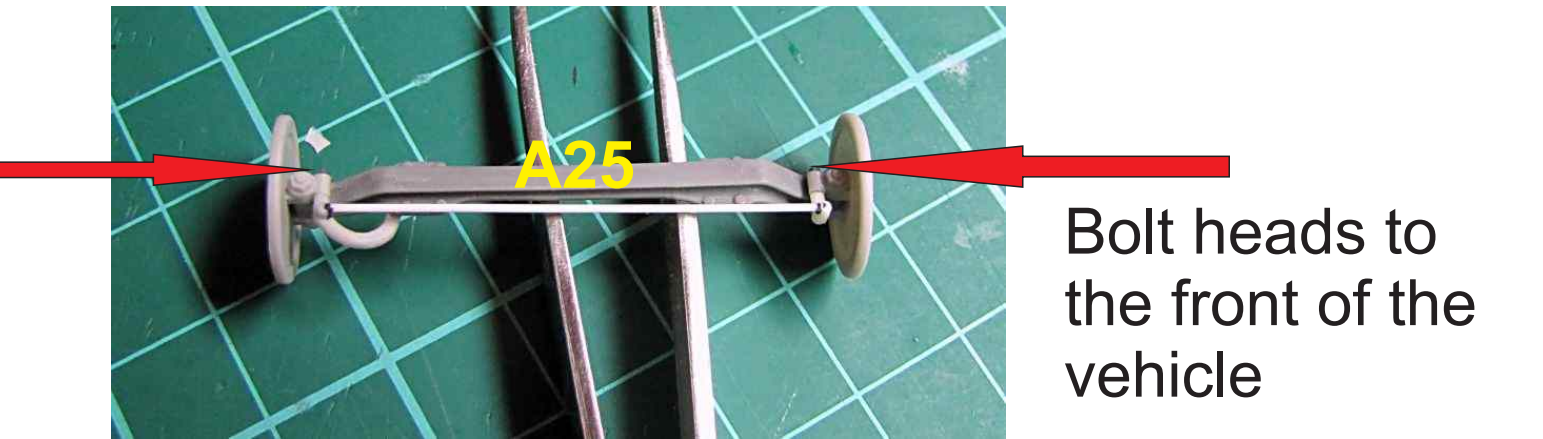
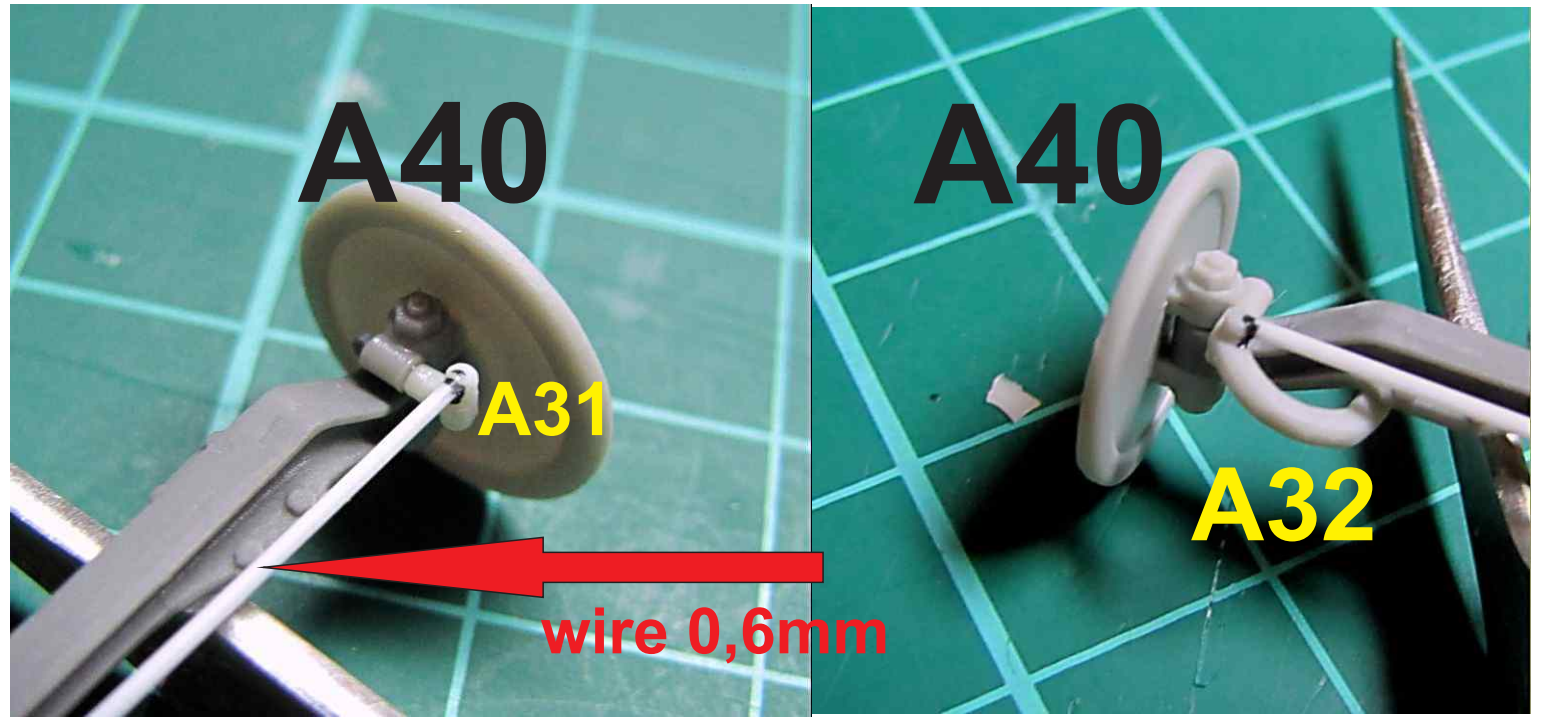

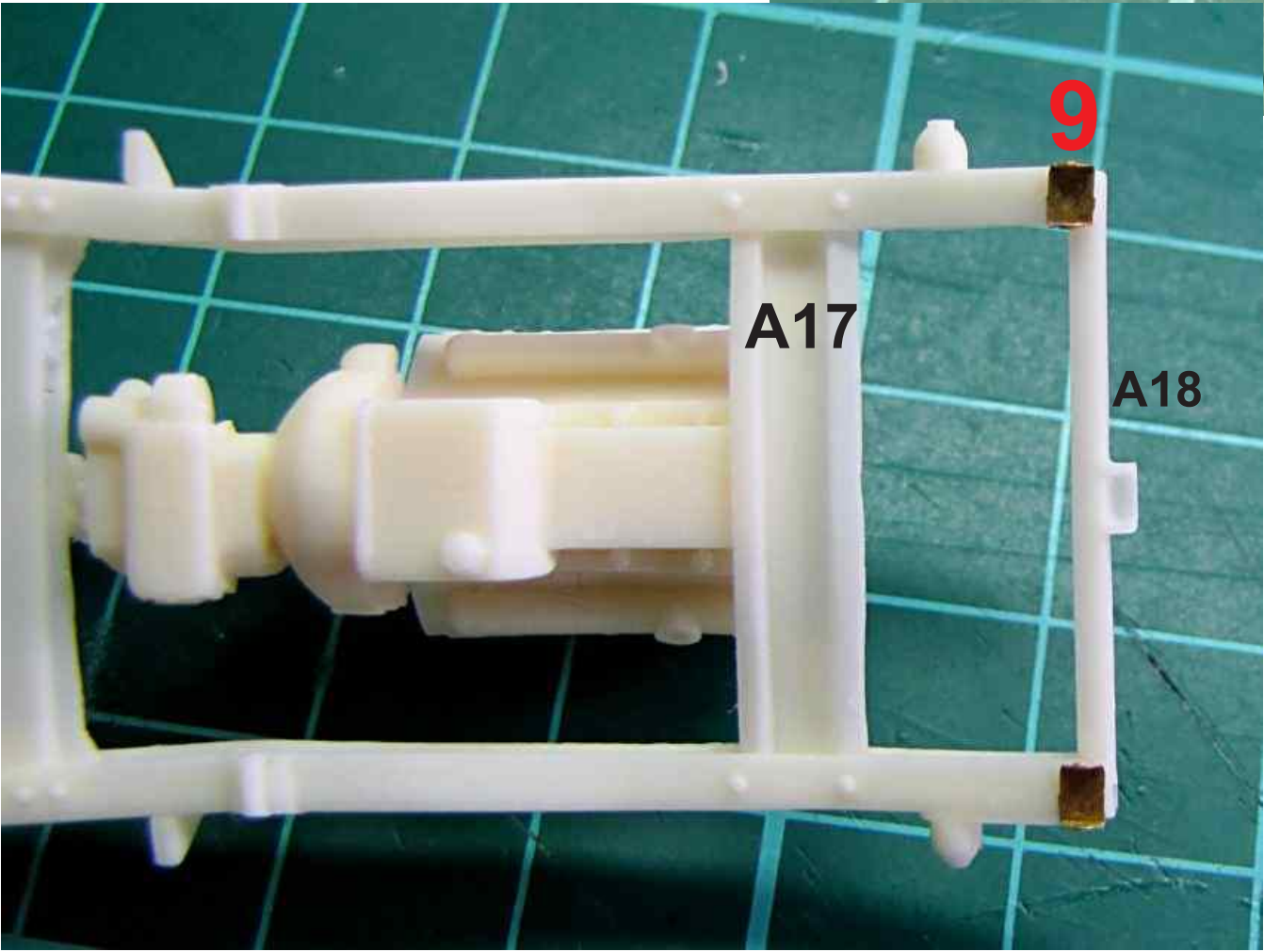
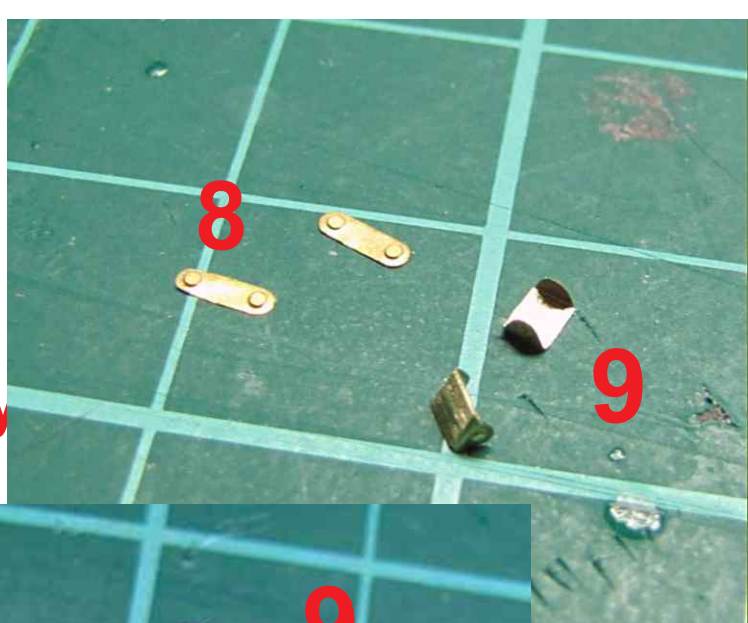
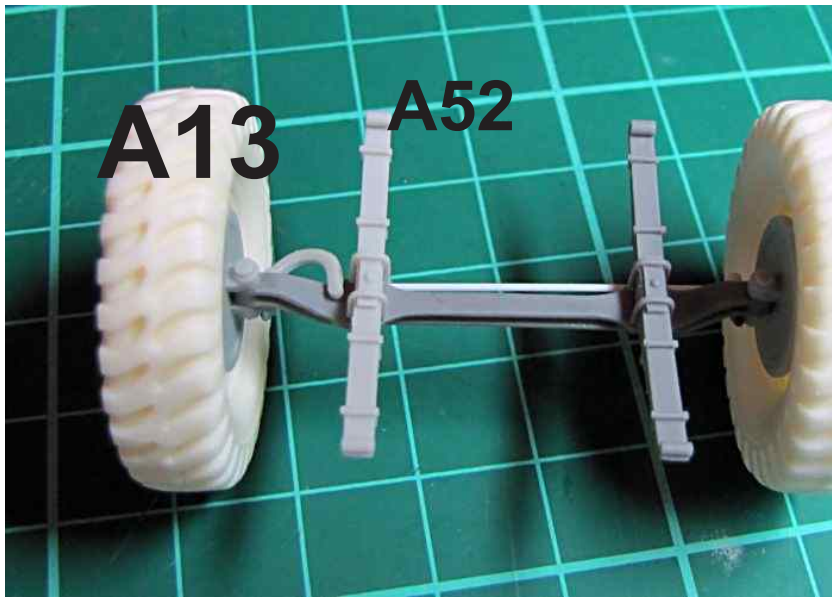



If wider gaps needed (empty vehicle) warm up the springs and bend them like shown

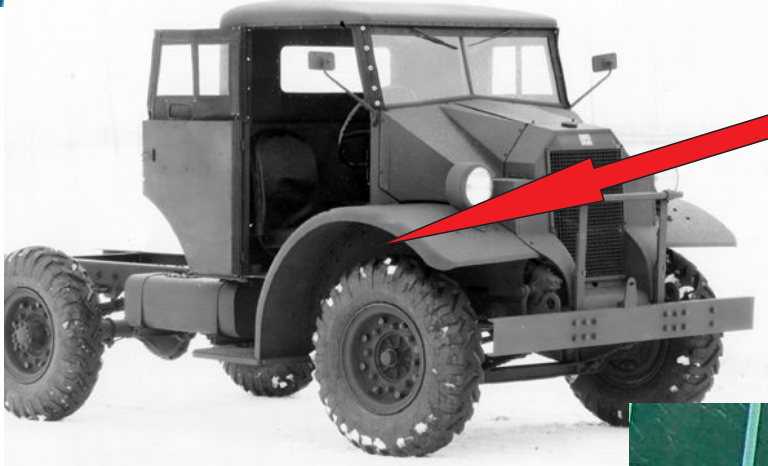

loaded vehicle



empty vehicle

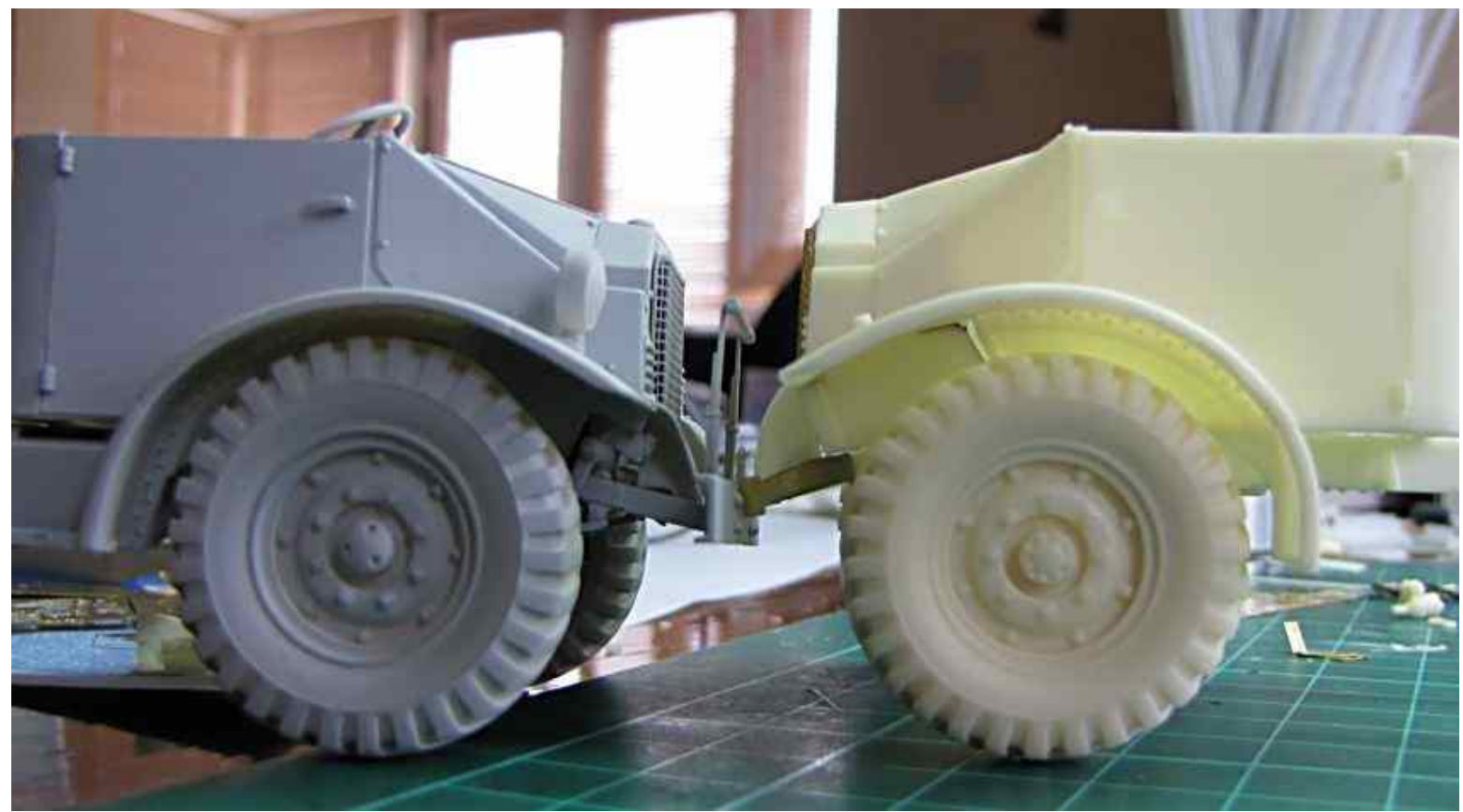

heavily loaded vehicle

empty vehicle

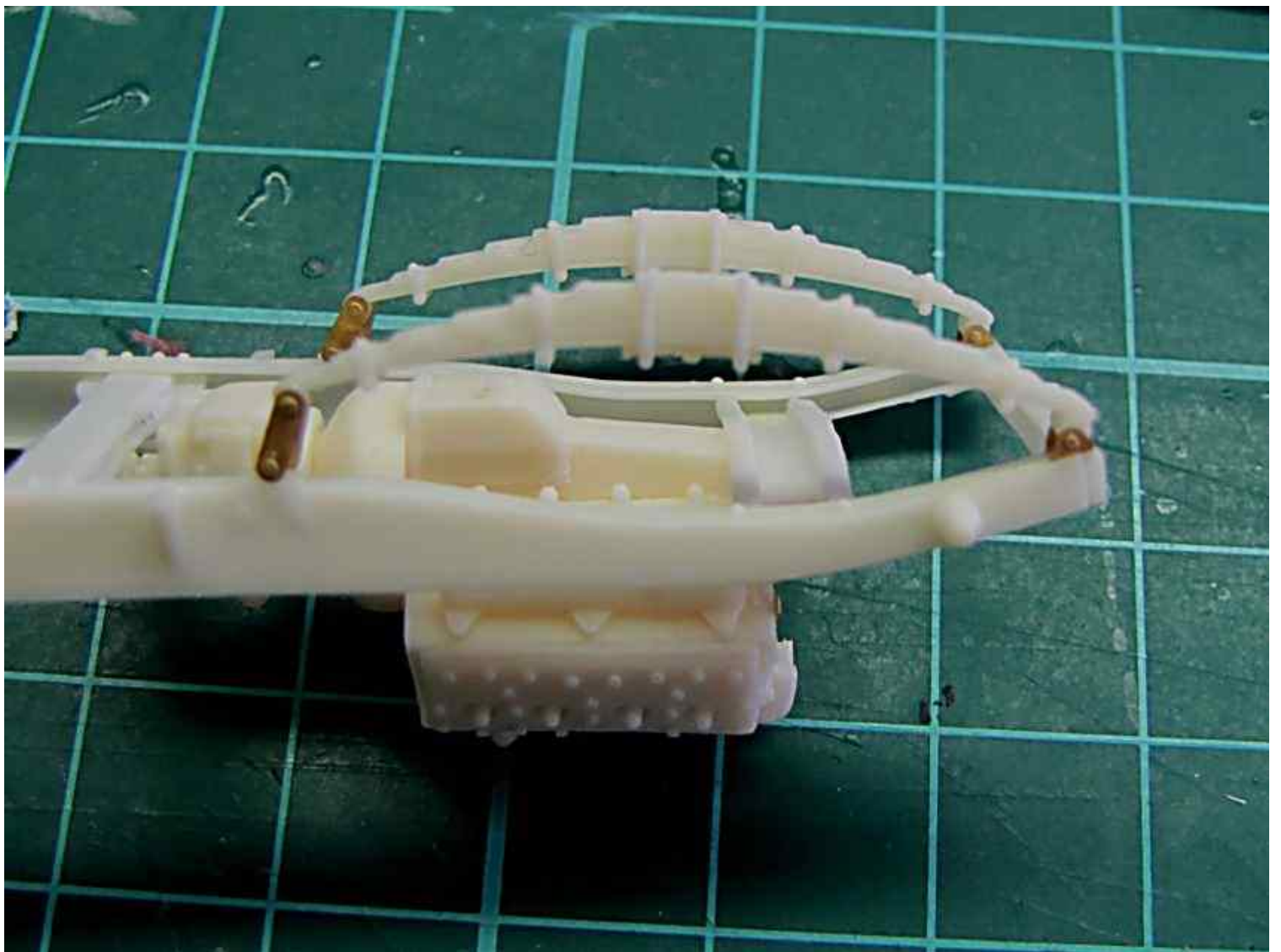

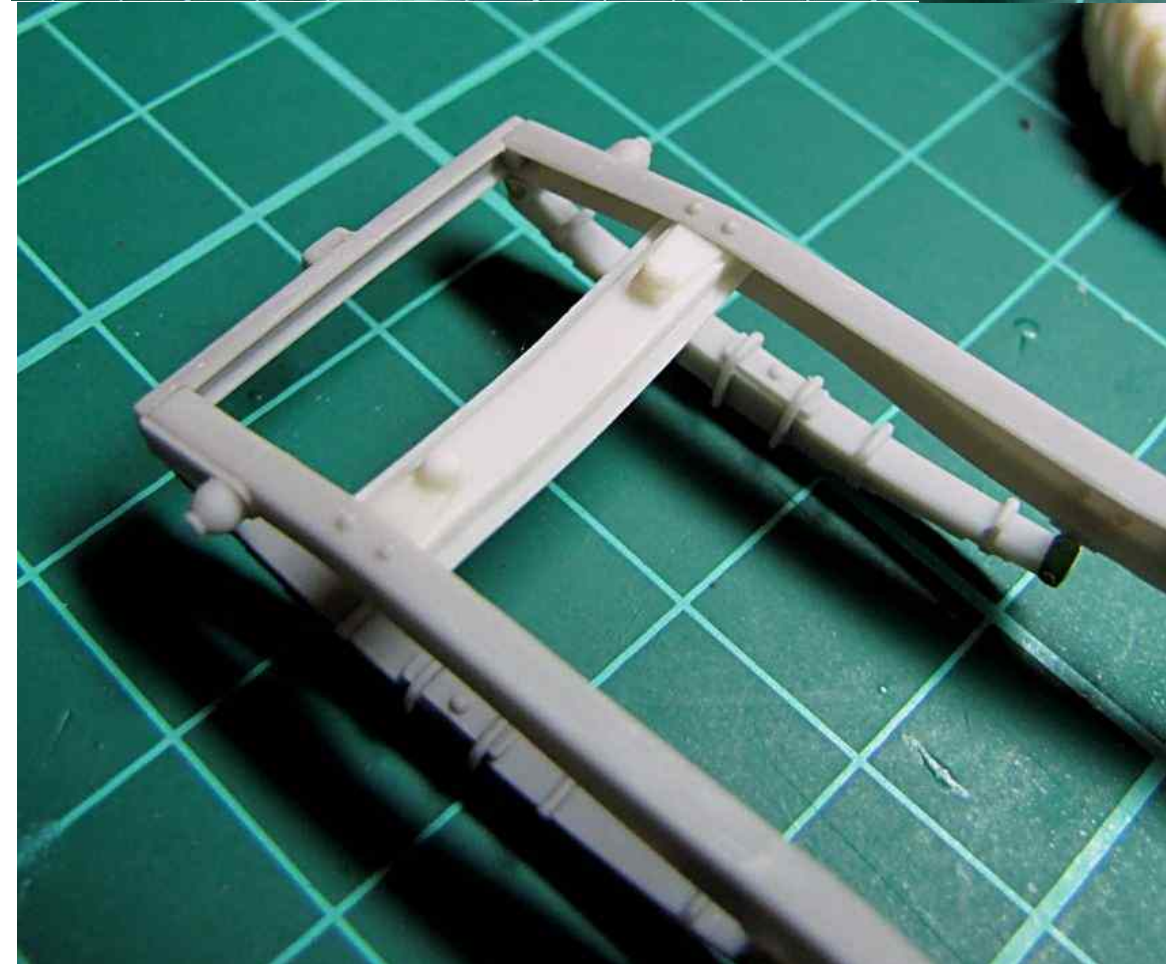
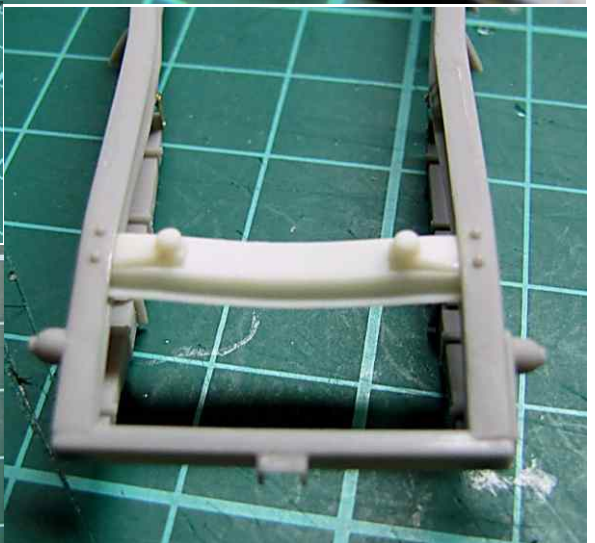
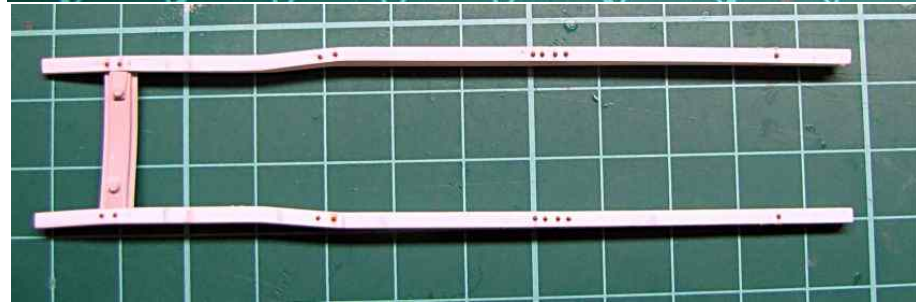
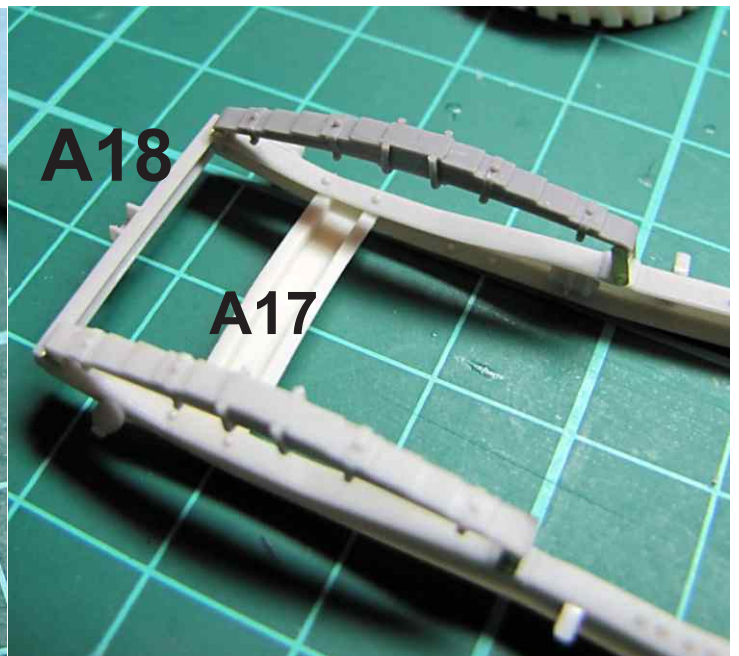

A photograph of a grey metal frame component, possibly a part of a prosthetic or orthotic device. It consists of several curved bars connected by vertical supports. The component is laid out on a green cutting mat with a white grid pattern.

A21

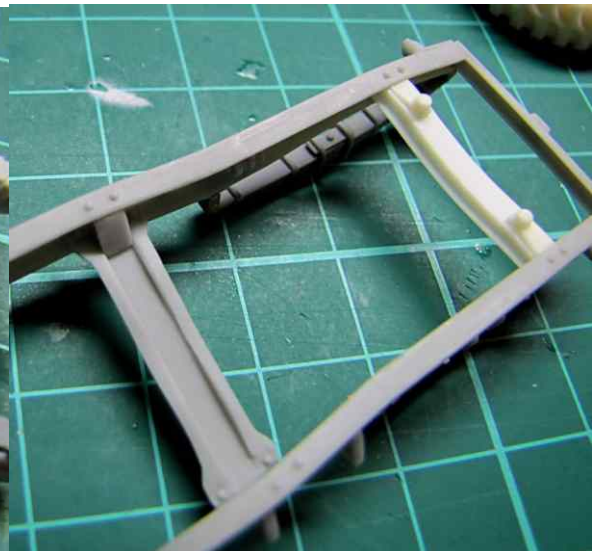
A close-up photograph of a specific joint or connection point on the grey metal frame component. It shows a horizontal bar connected to a vertical support. The component is on a green cutting mat.

A36

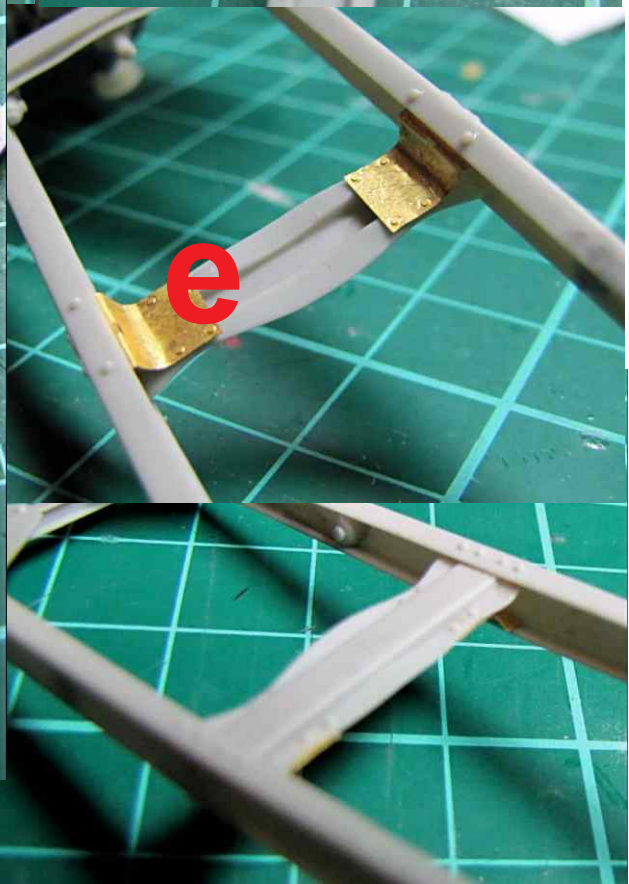
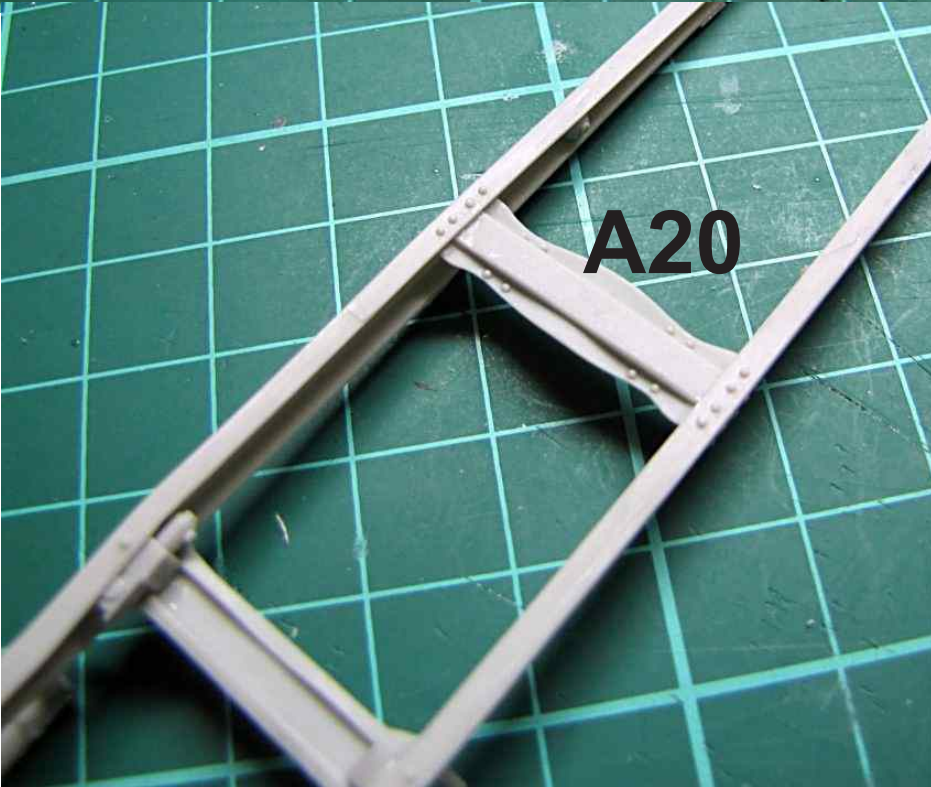

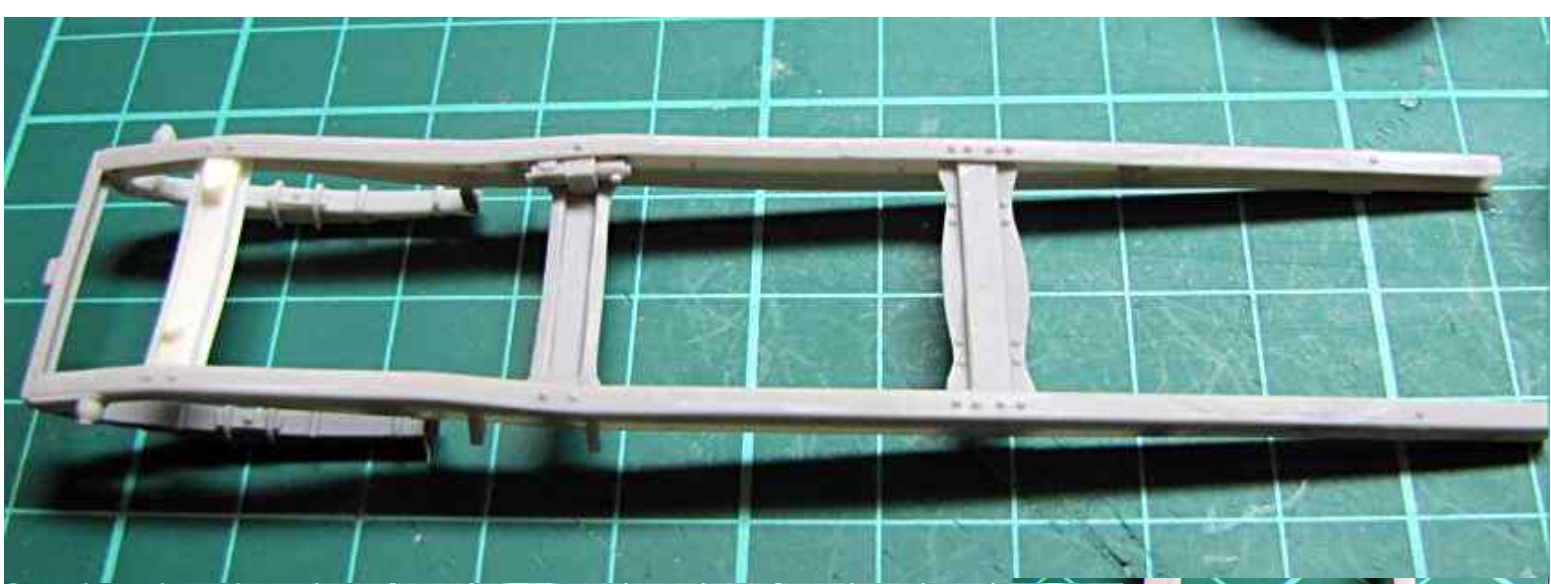

A19

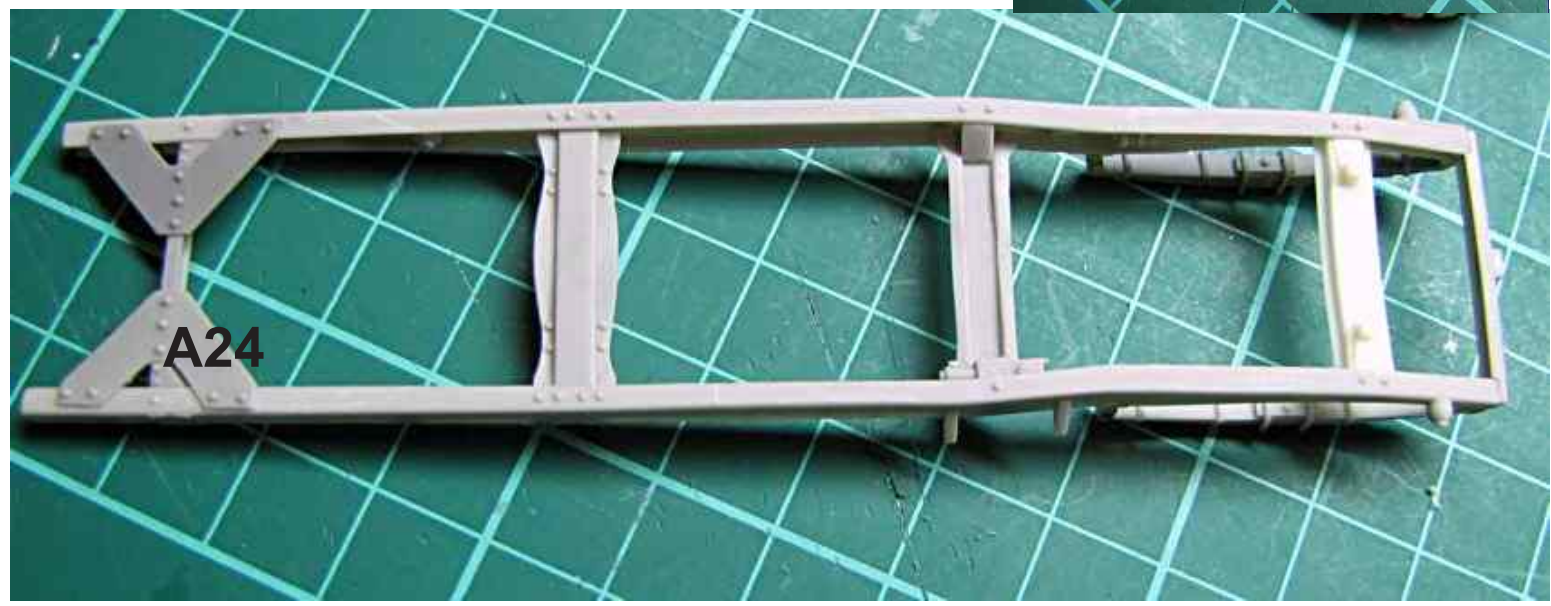

A24

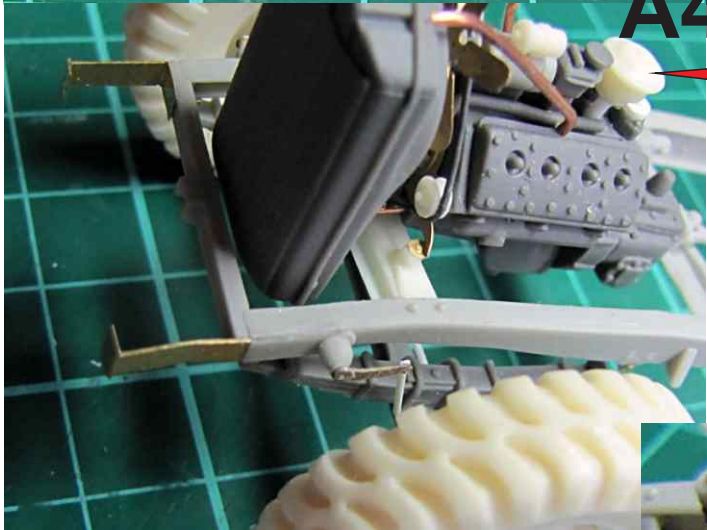
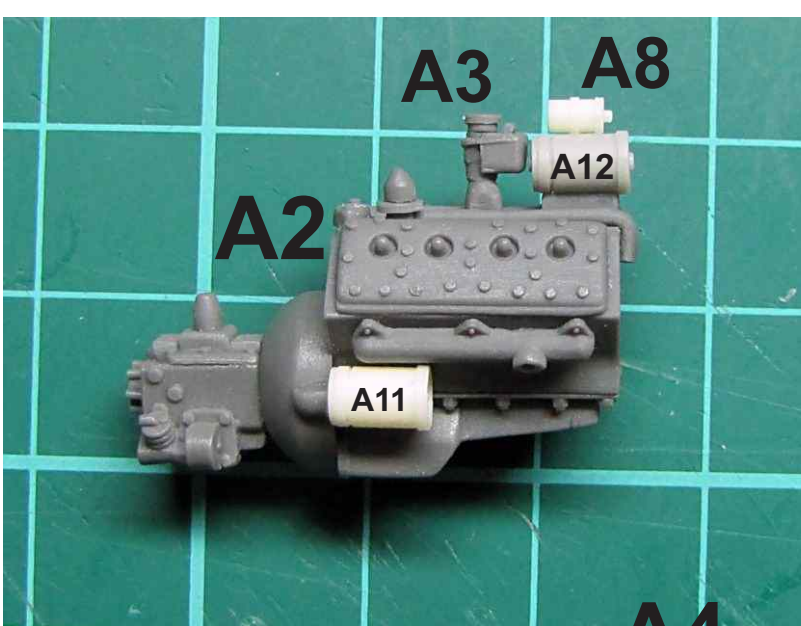

correct filter (A4) position for this vehicle, dont mind its position in other pics

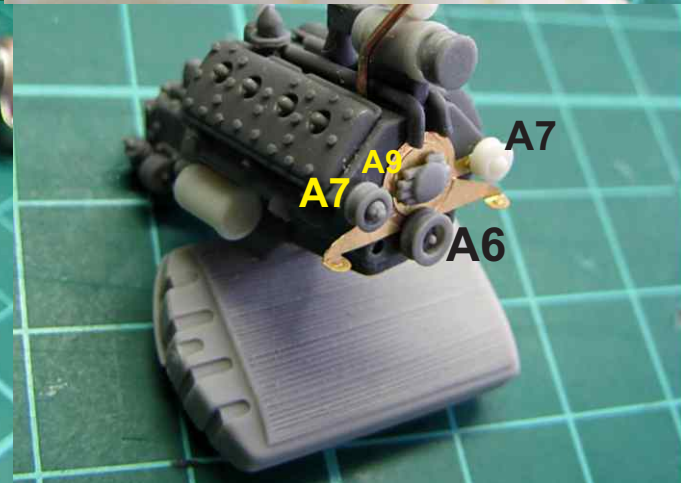
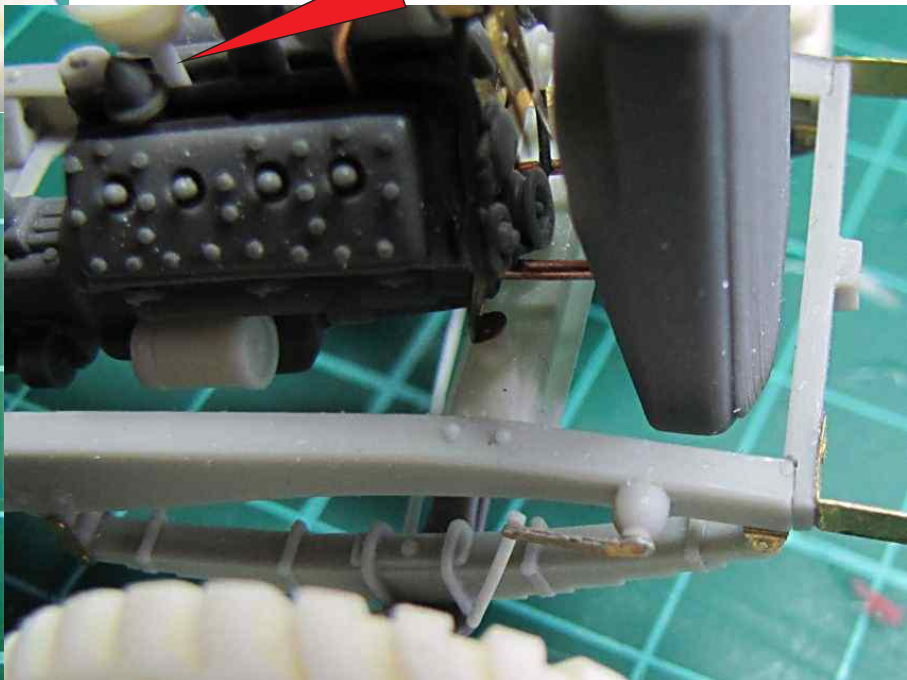
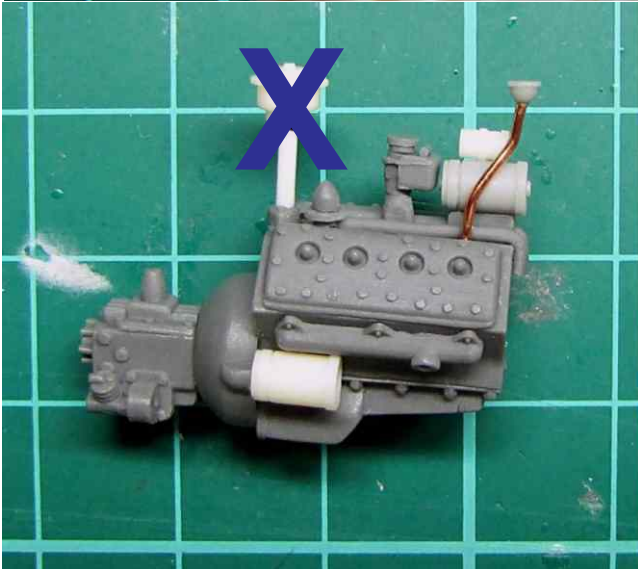

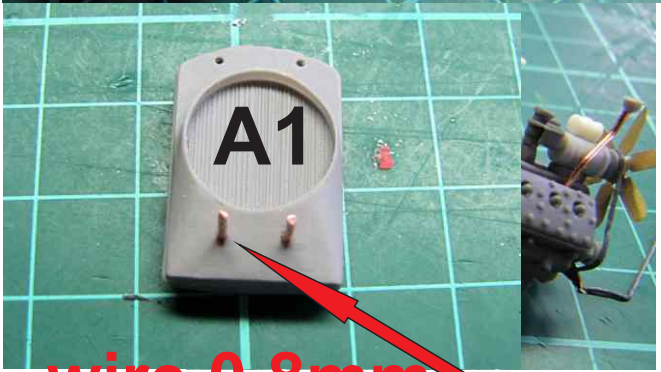
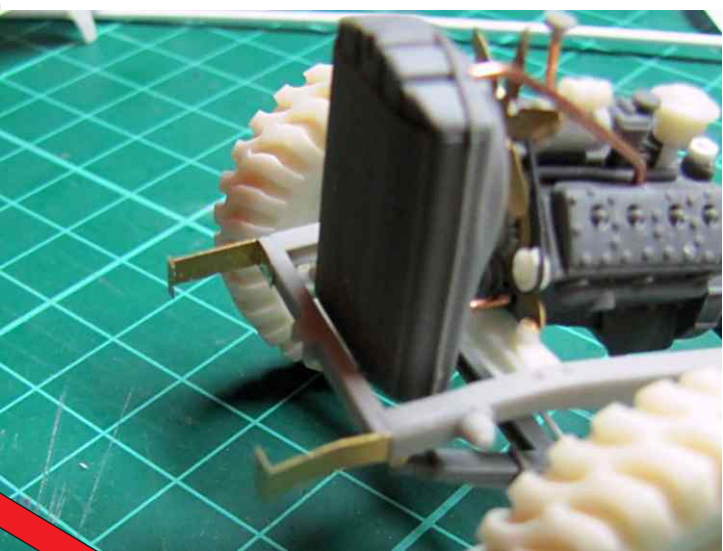
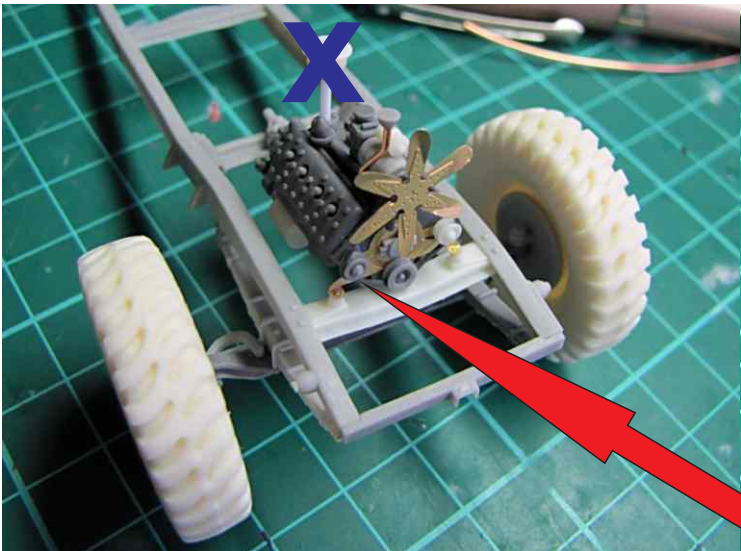

wire 0,8mm



rubber thread or lead wire used for belt
I recommend to glue engine just on A17 now, not on A21 or leave it all for later, when checked and fitted with cab engine cover A56. The engine has to fit exactly into it.

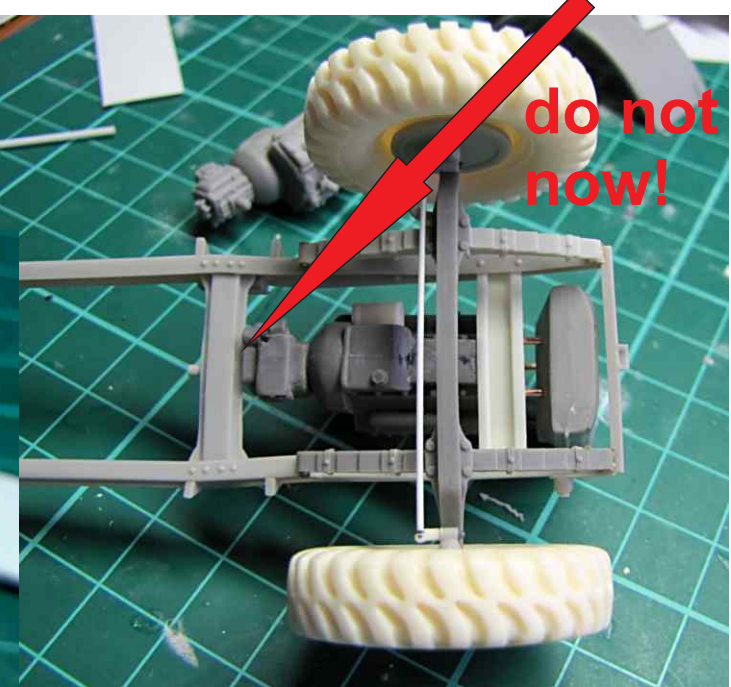

do not glue now!



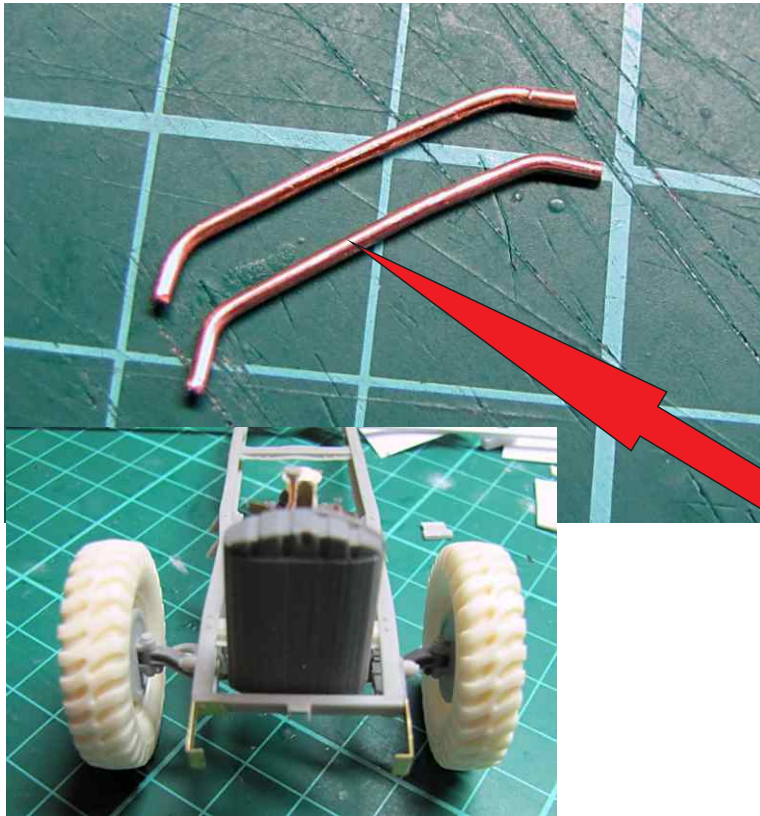
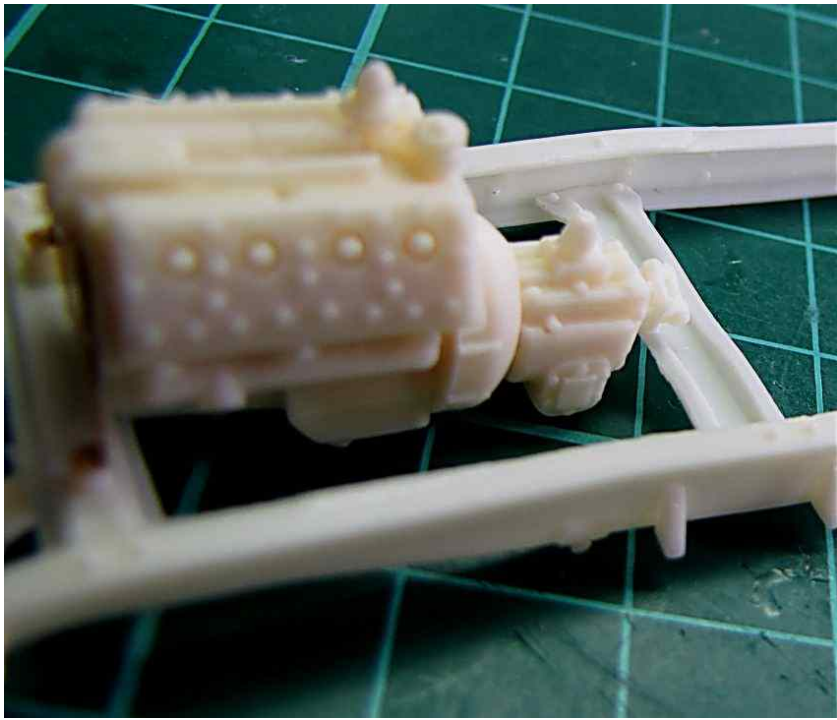

wire 0,8mm



Example of engine wiring

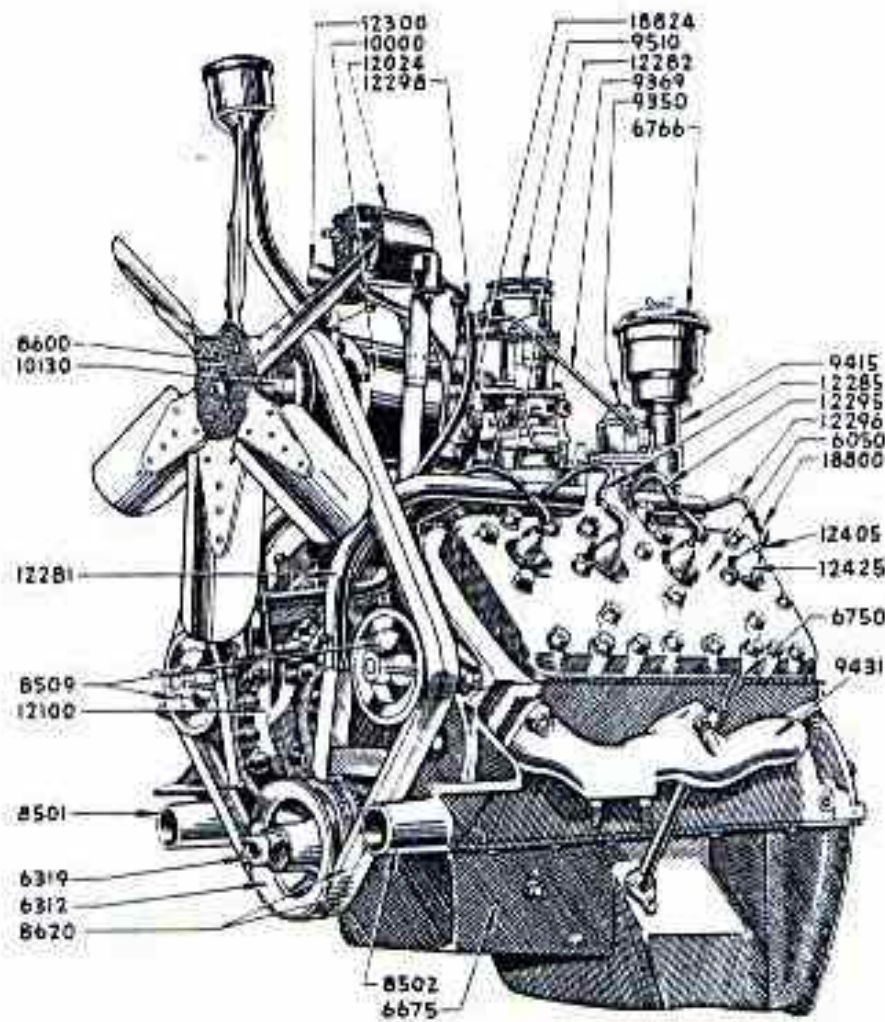
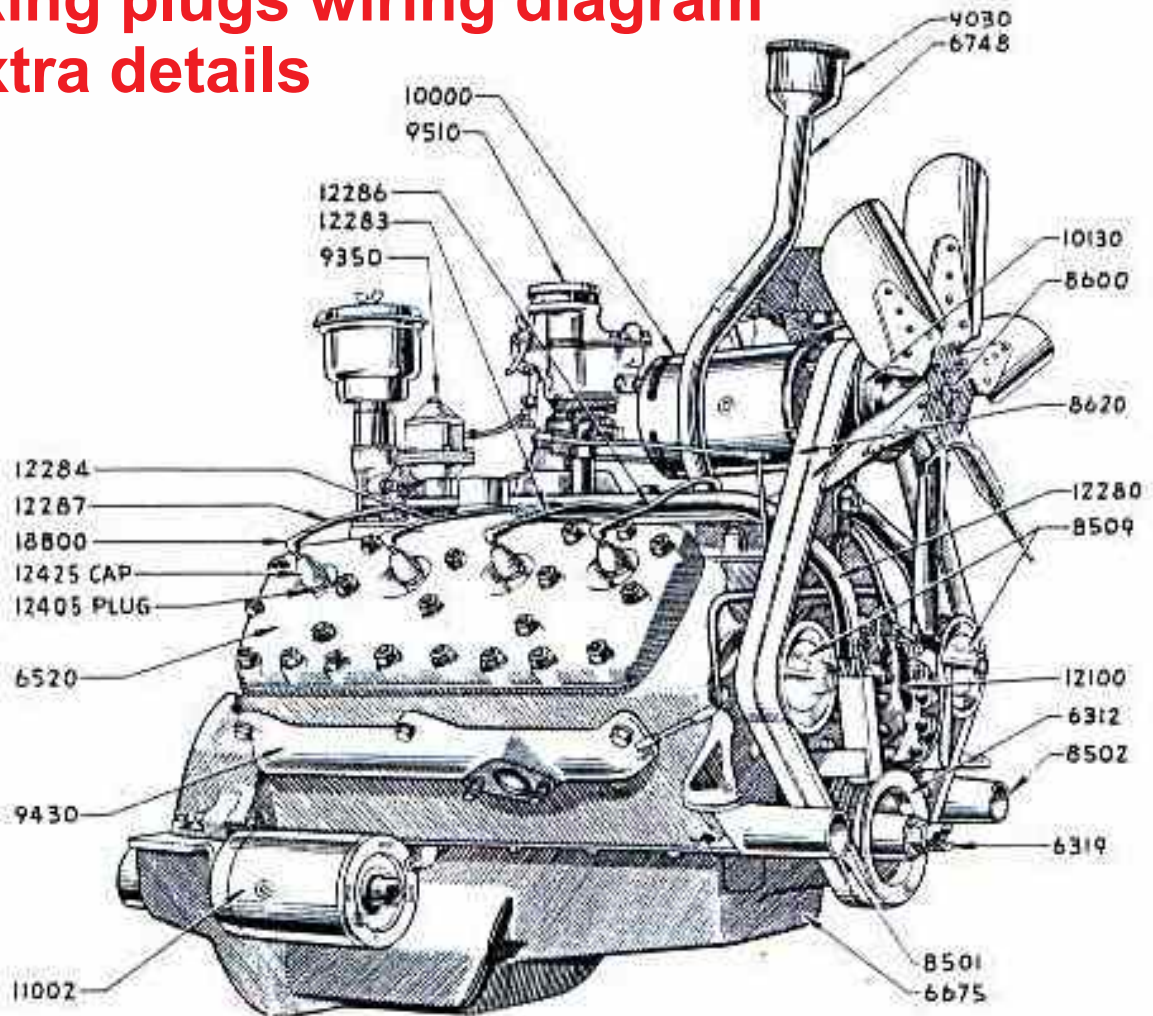
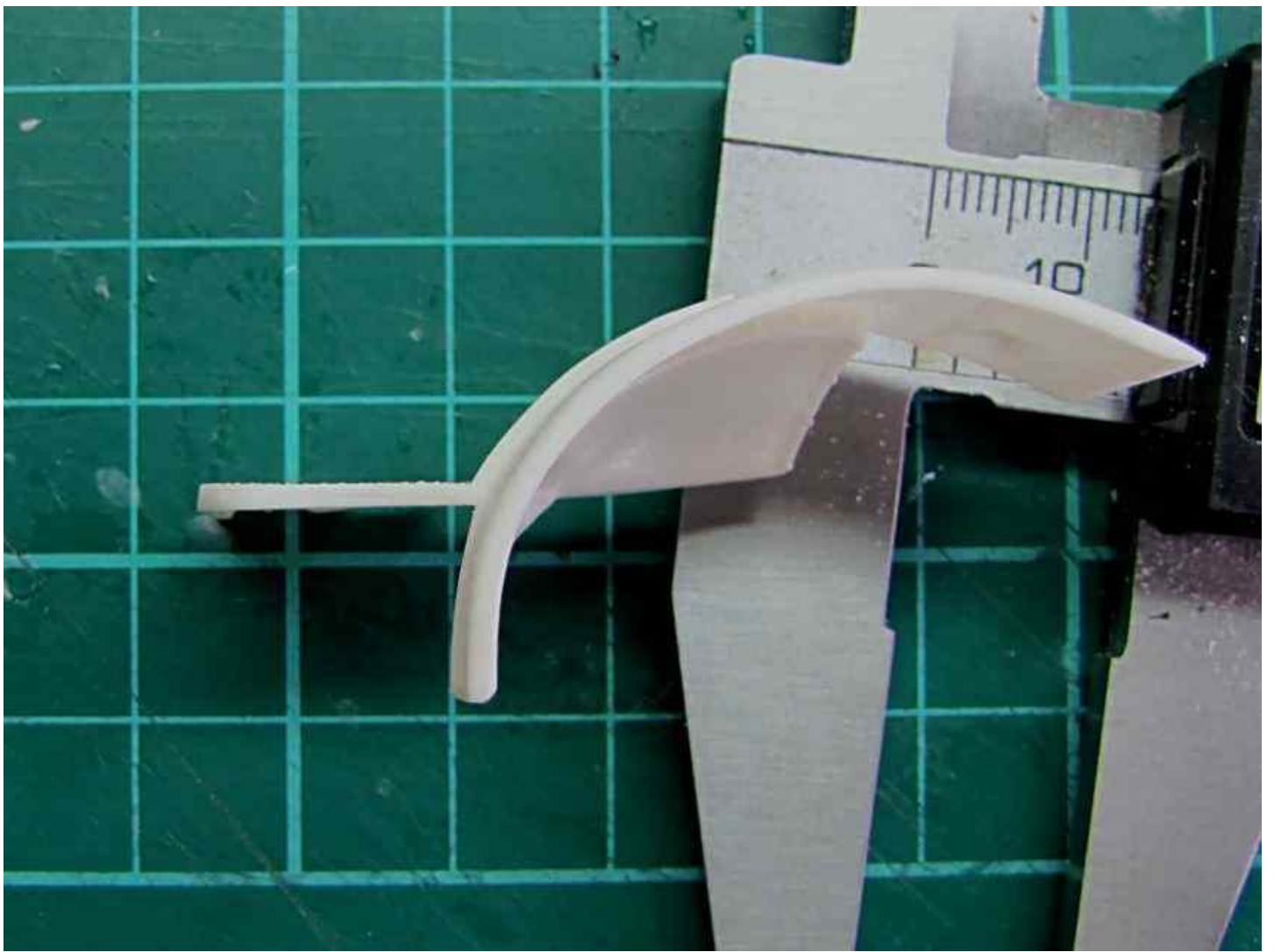

Fig. 1

**sparking plugs wiring diagram
for extra details**





correct shape of the fenders

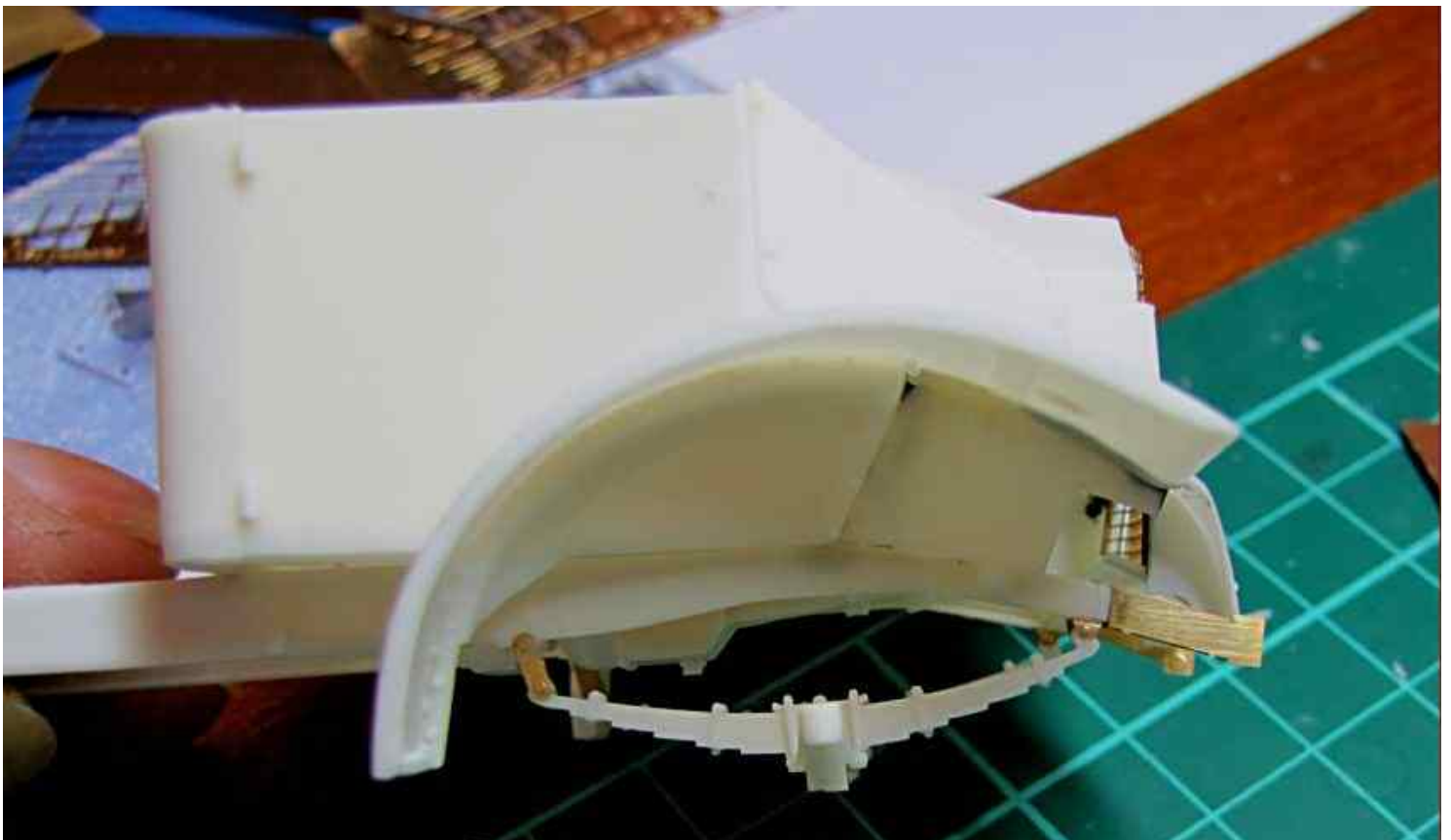

The cab.

This step needs a bit extra care and keeping all joints right. Once A54 and A55 are glued, check the shape - if any seems to be warped a bit, heat up lightly with hair dryer and set it properly. It might sound difficult, but it is very easy

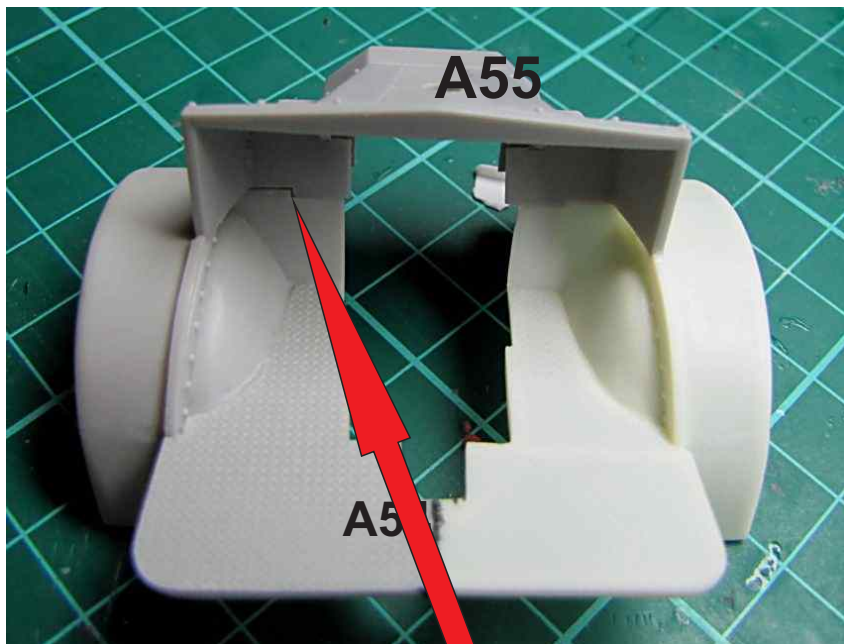

little filling (thicker C/A or any filler) might be needed here

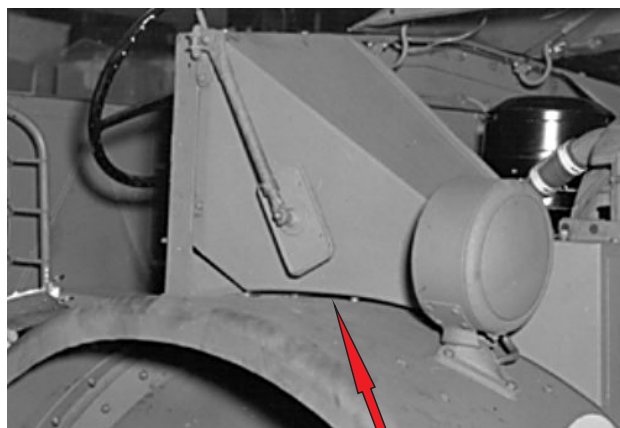

small gap

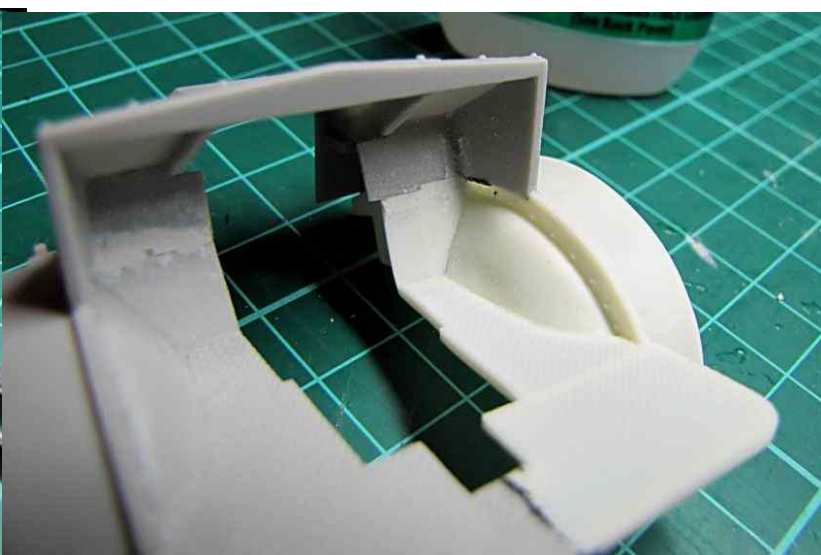
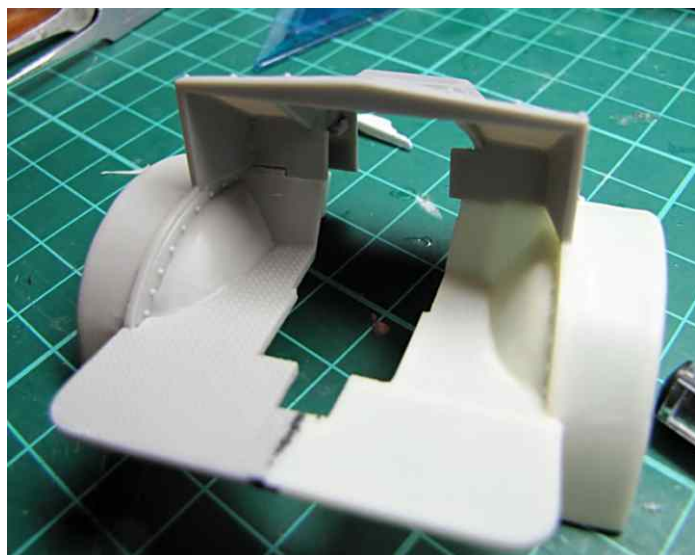

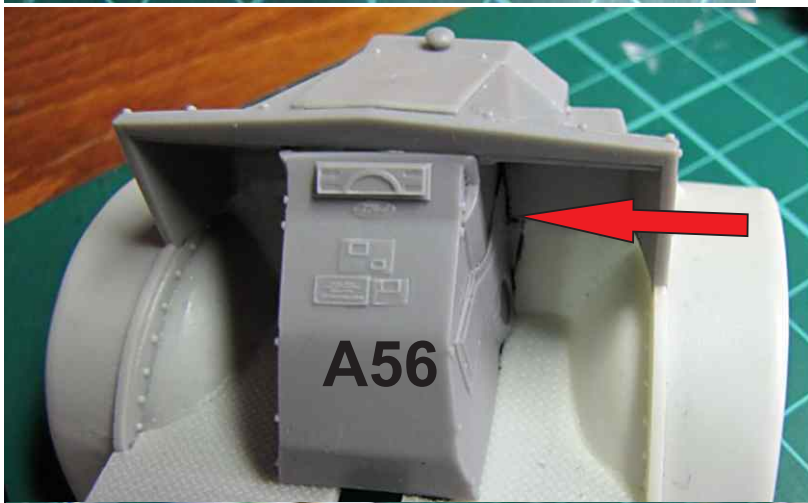
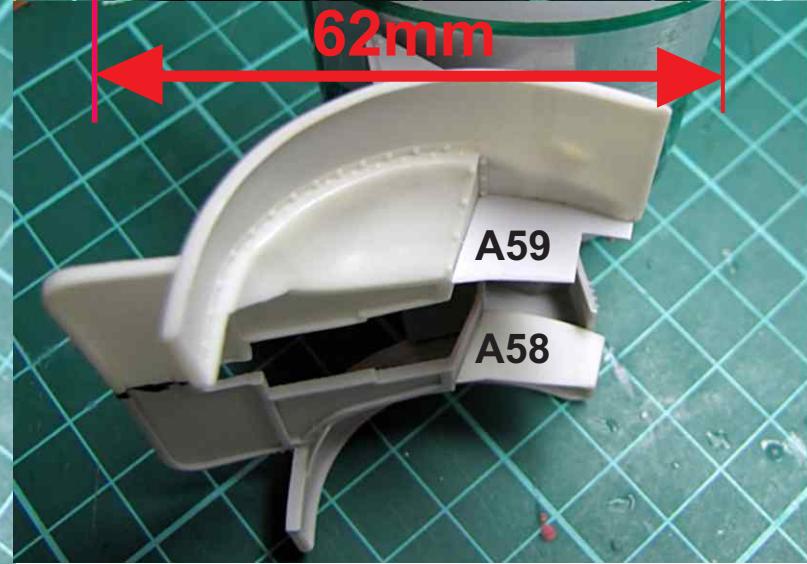
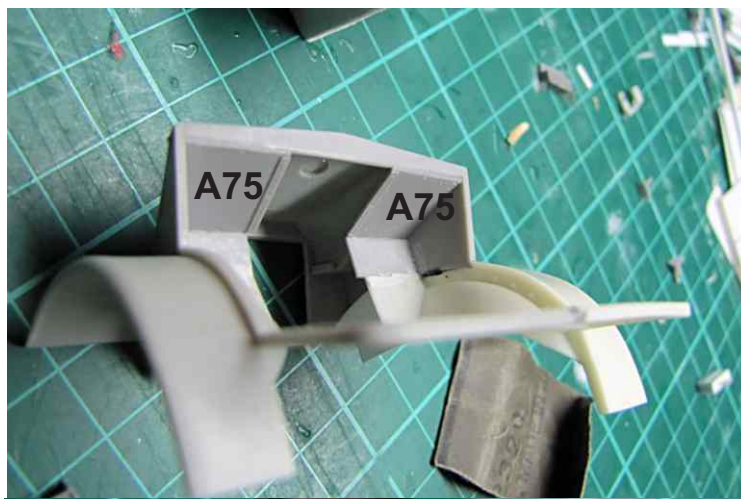

glue first here



then glue top

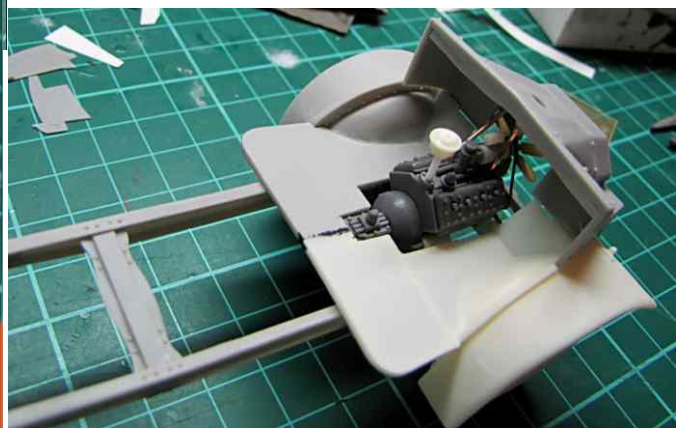

Engine cover - glue on step by step as shown in pictures. Its edge mounted on the floor must be glued on the floor to keep whole opening free for engine, pull right and left sides to the sides - see arrows in the picture



Hold A56 sides out and glue on floor behind the opening edges - to get enough space for the engine



Glue this side and the floor, make sure the wall is out of the floor opening

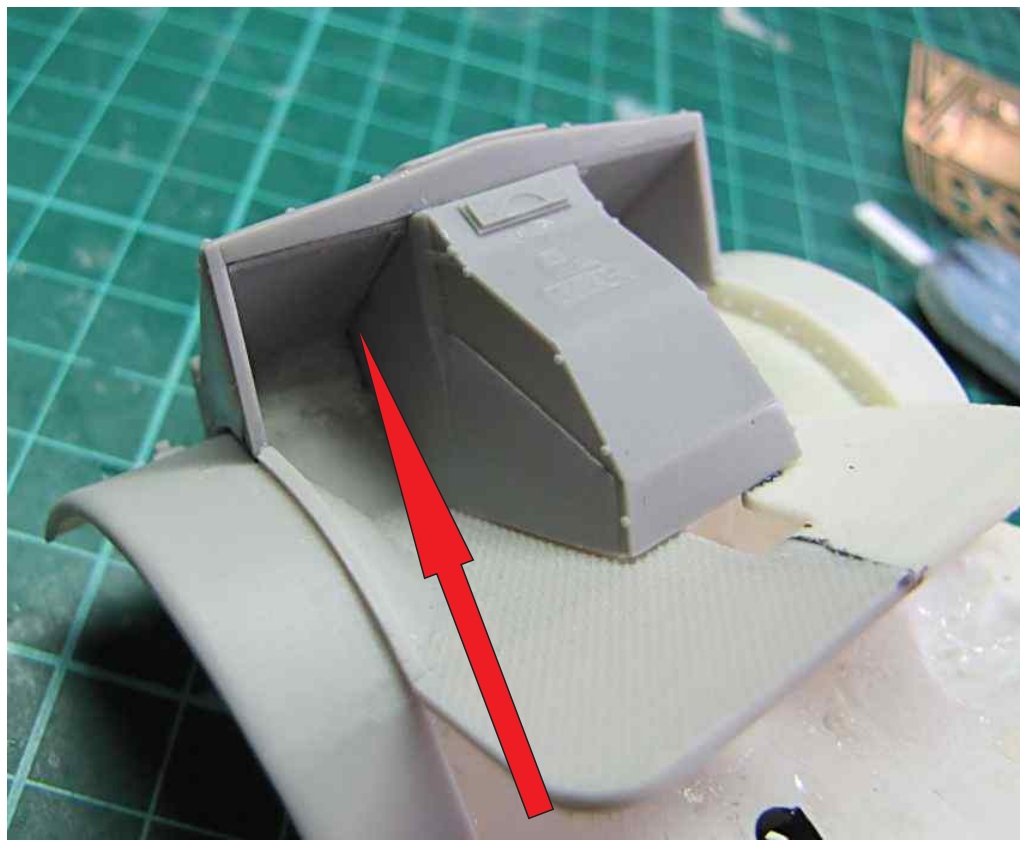

then glue there

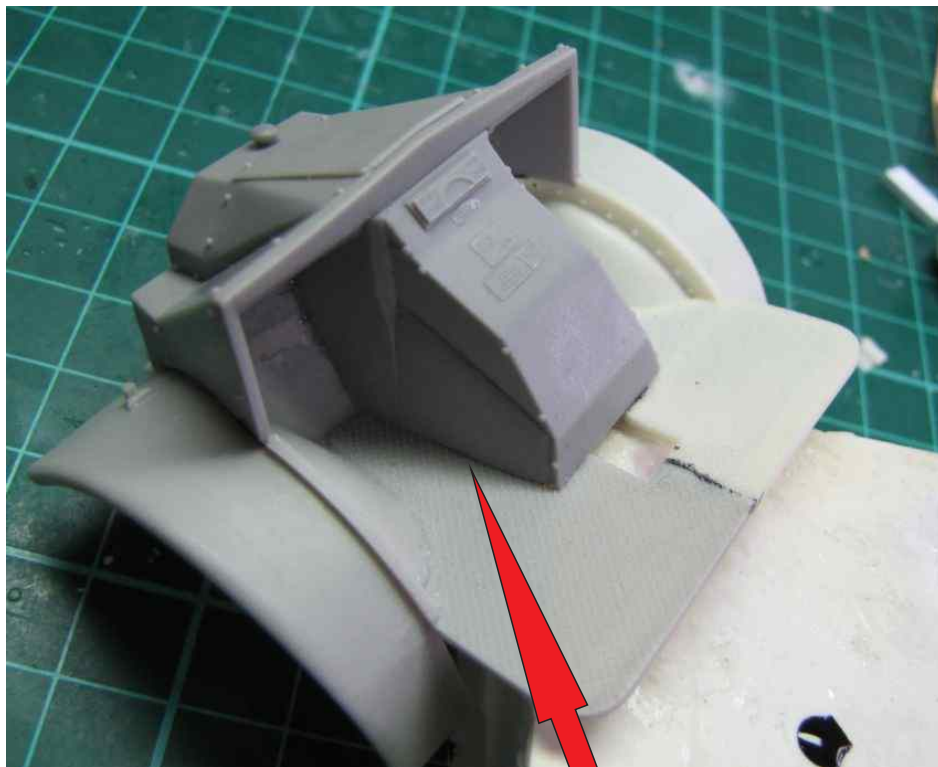

**Glue this side and
the floor, make sure
the wall is out of the
floor opening**

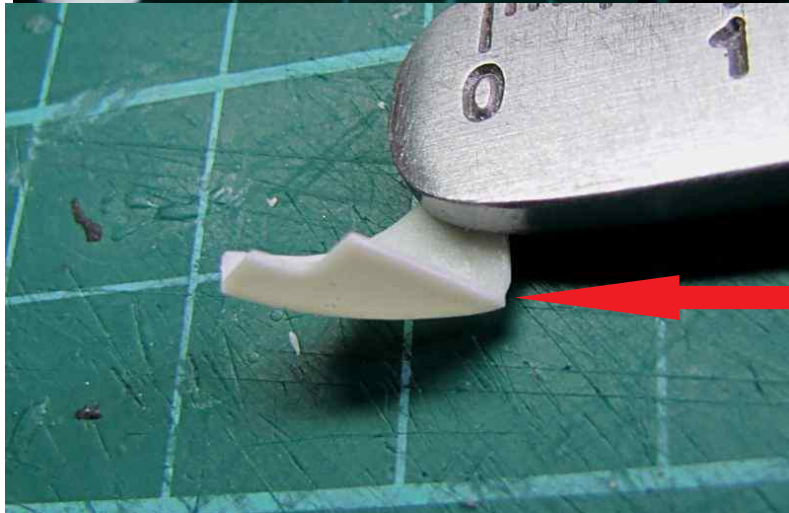
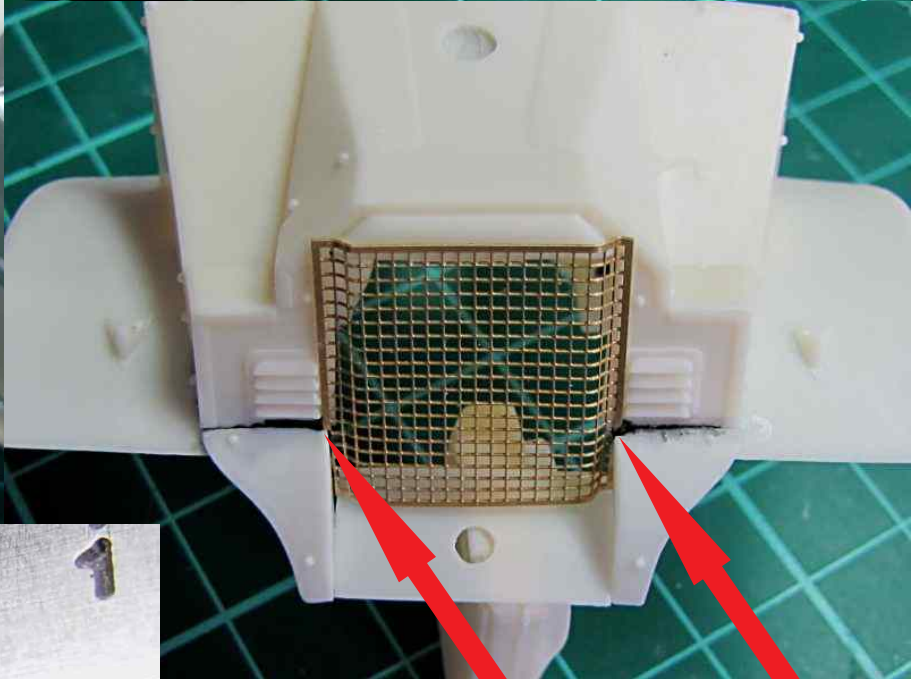
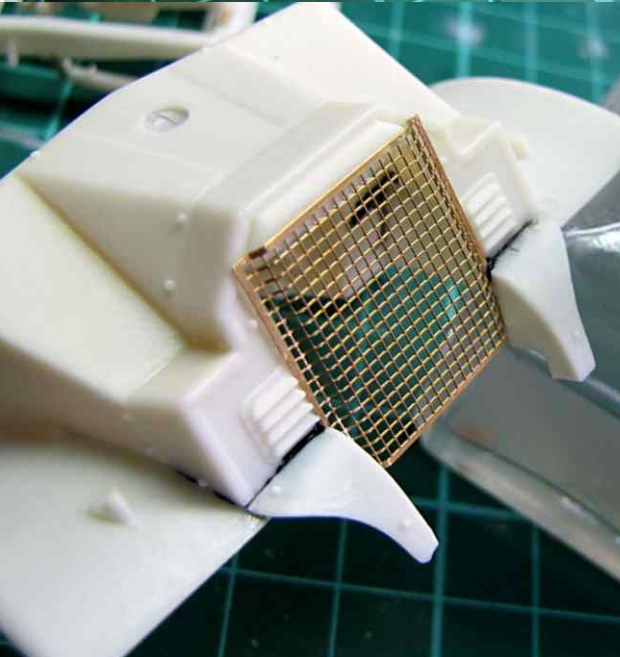
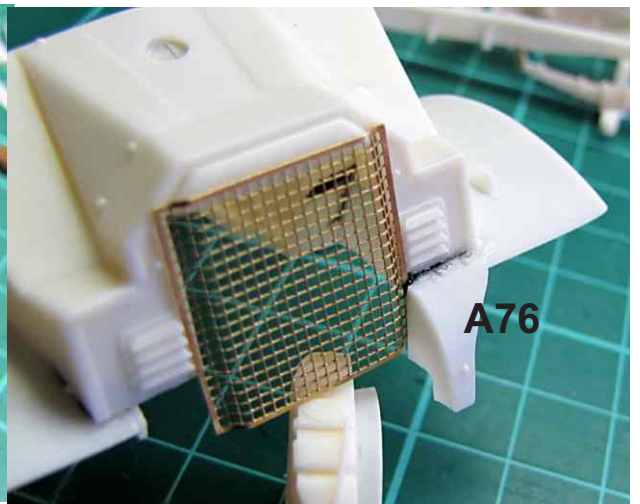
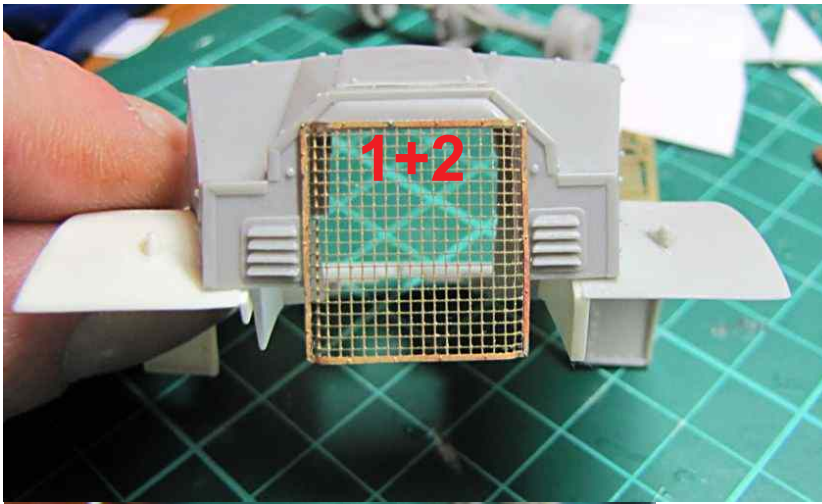

I sanded off tiny bit of A76 edge for thickness of the PE mesh to make assembly easy

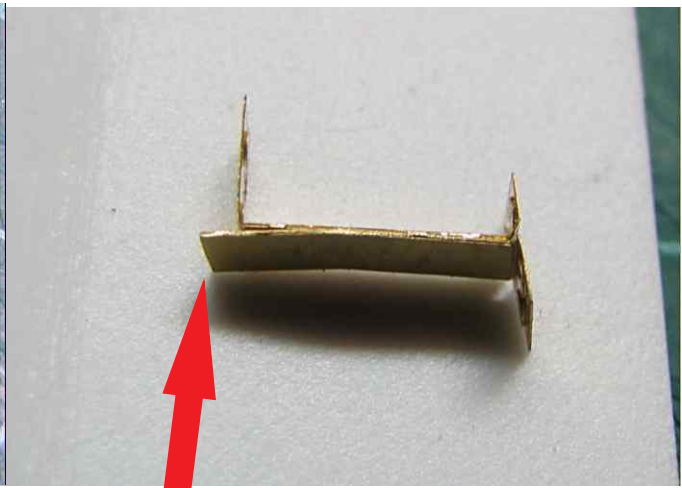
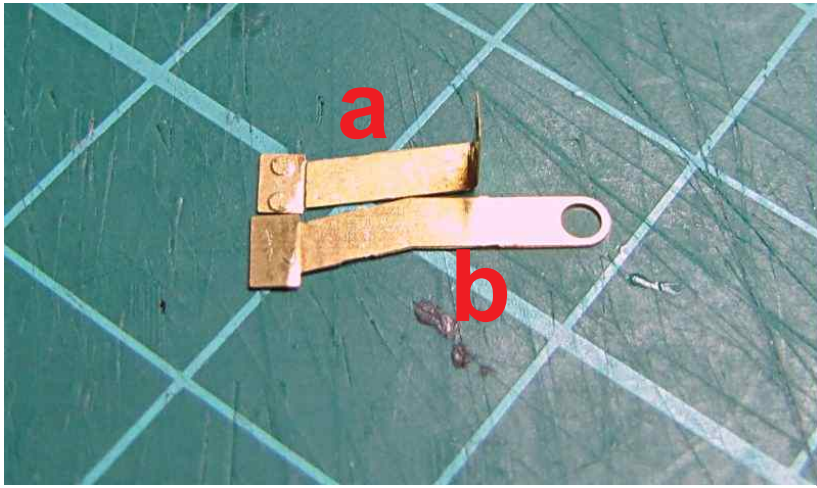

for this vehicle cut PE "b" here

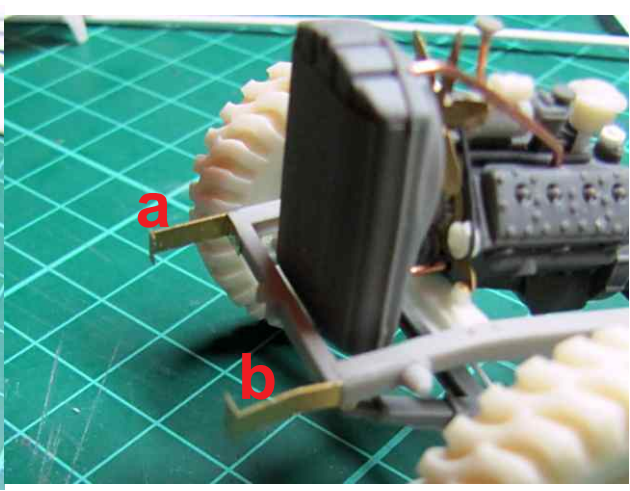
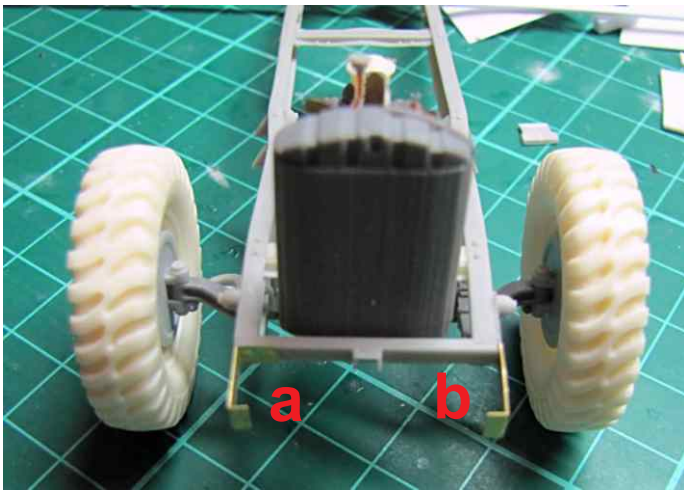

**bent to check cab position
when glued on, bend both
PE ends back (straight)**

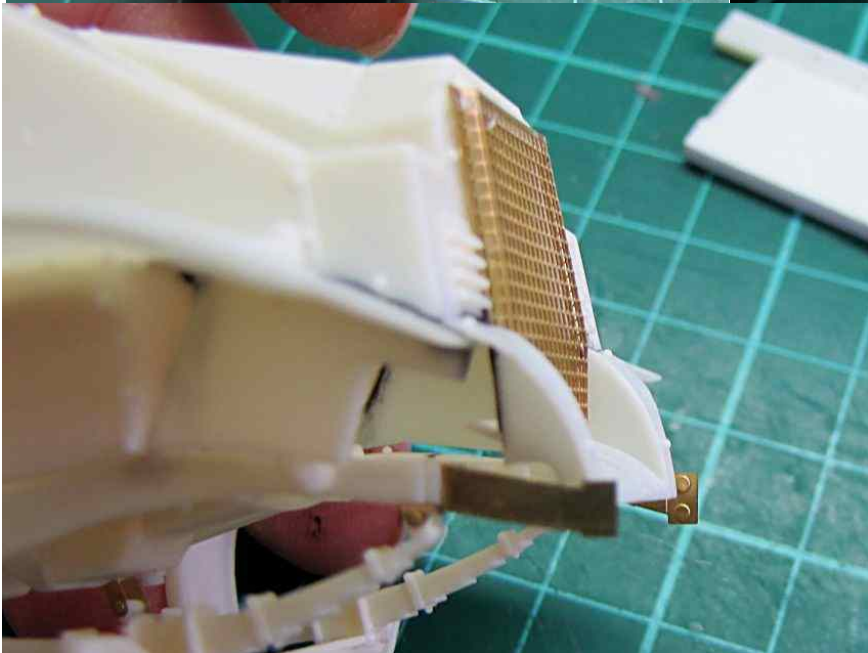
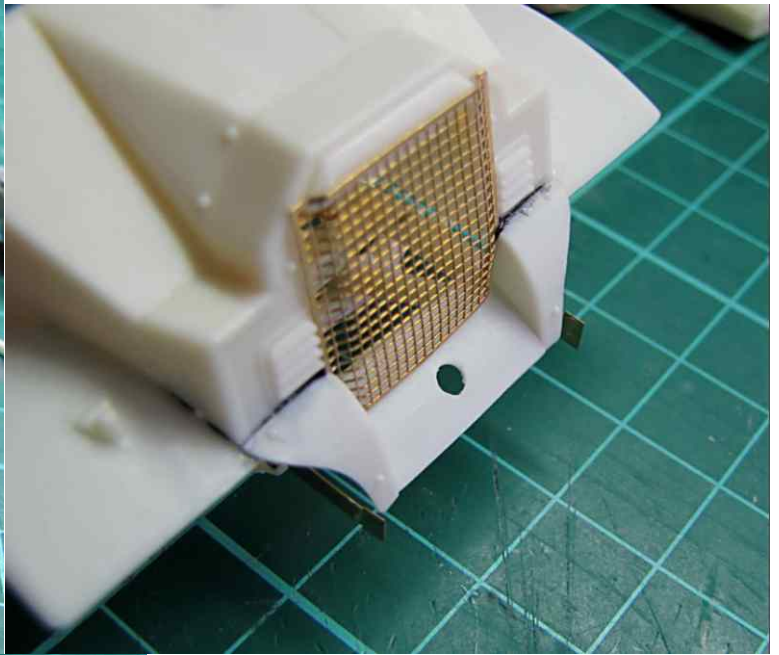
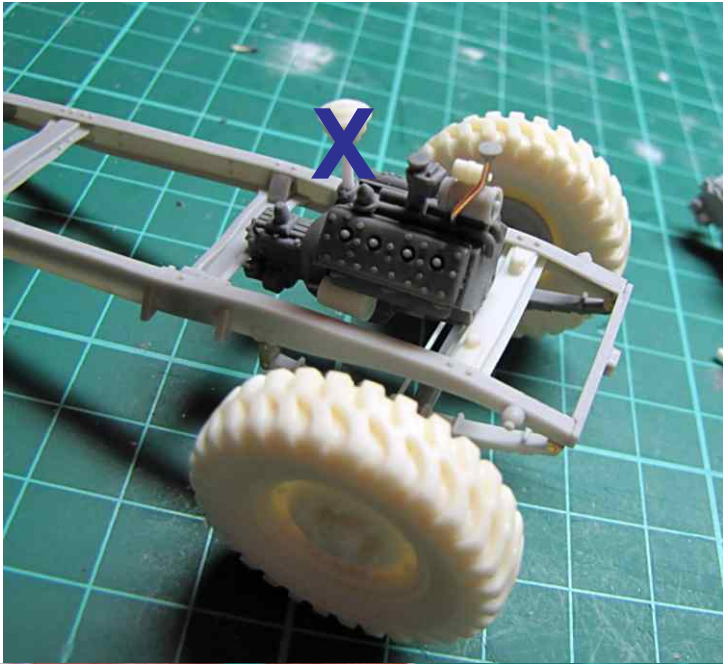
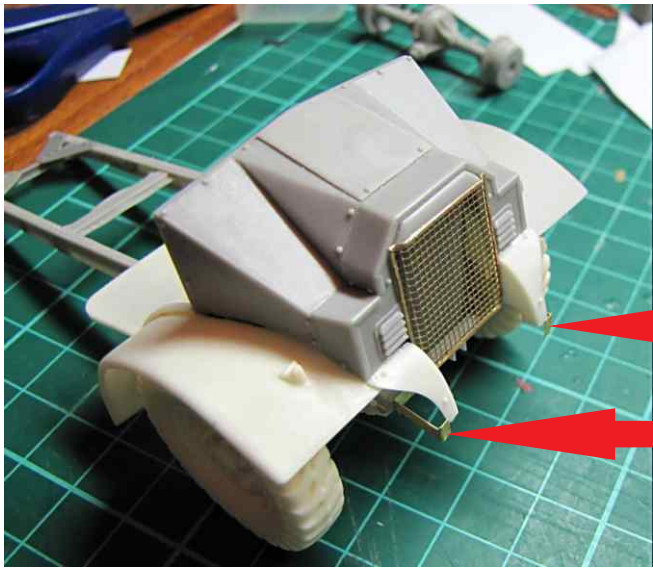

Once you have checked and fitted cab with engine, secure the engine in right place and glue also the cab on the frame
Important - the right position of the cab
the fenders have to face exactly the step board's mountings on the frame - see the arrows bellow, do not put the cab to forward or back!!!!

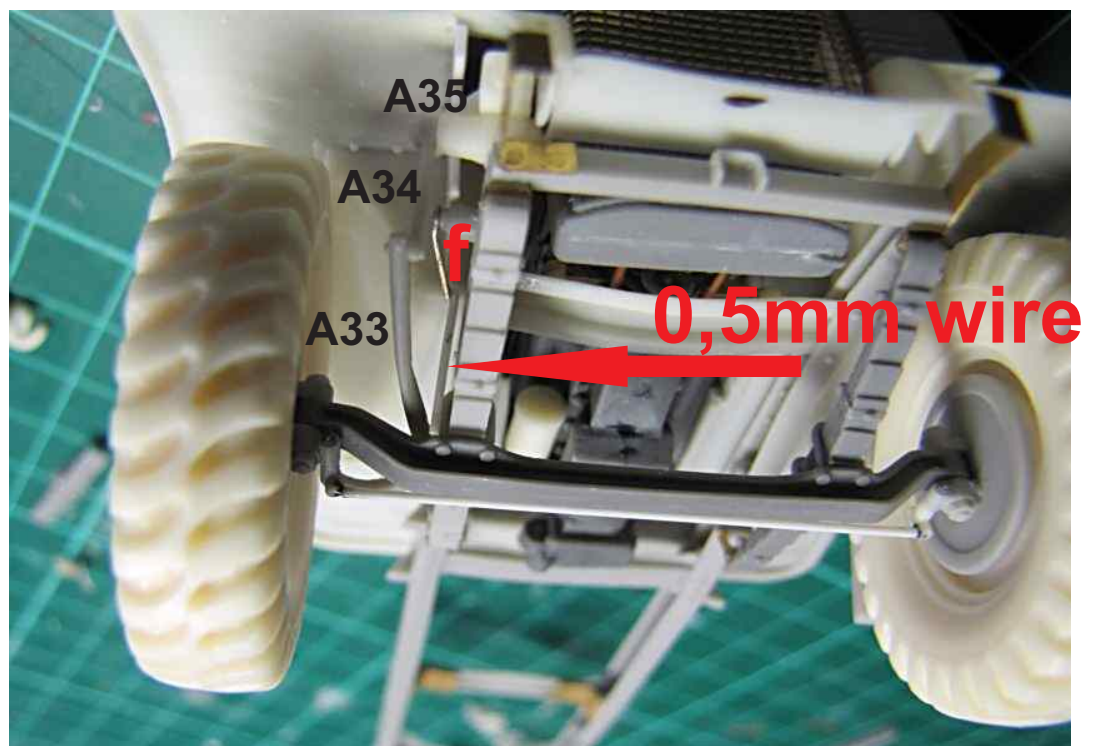
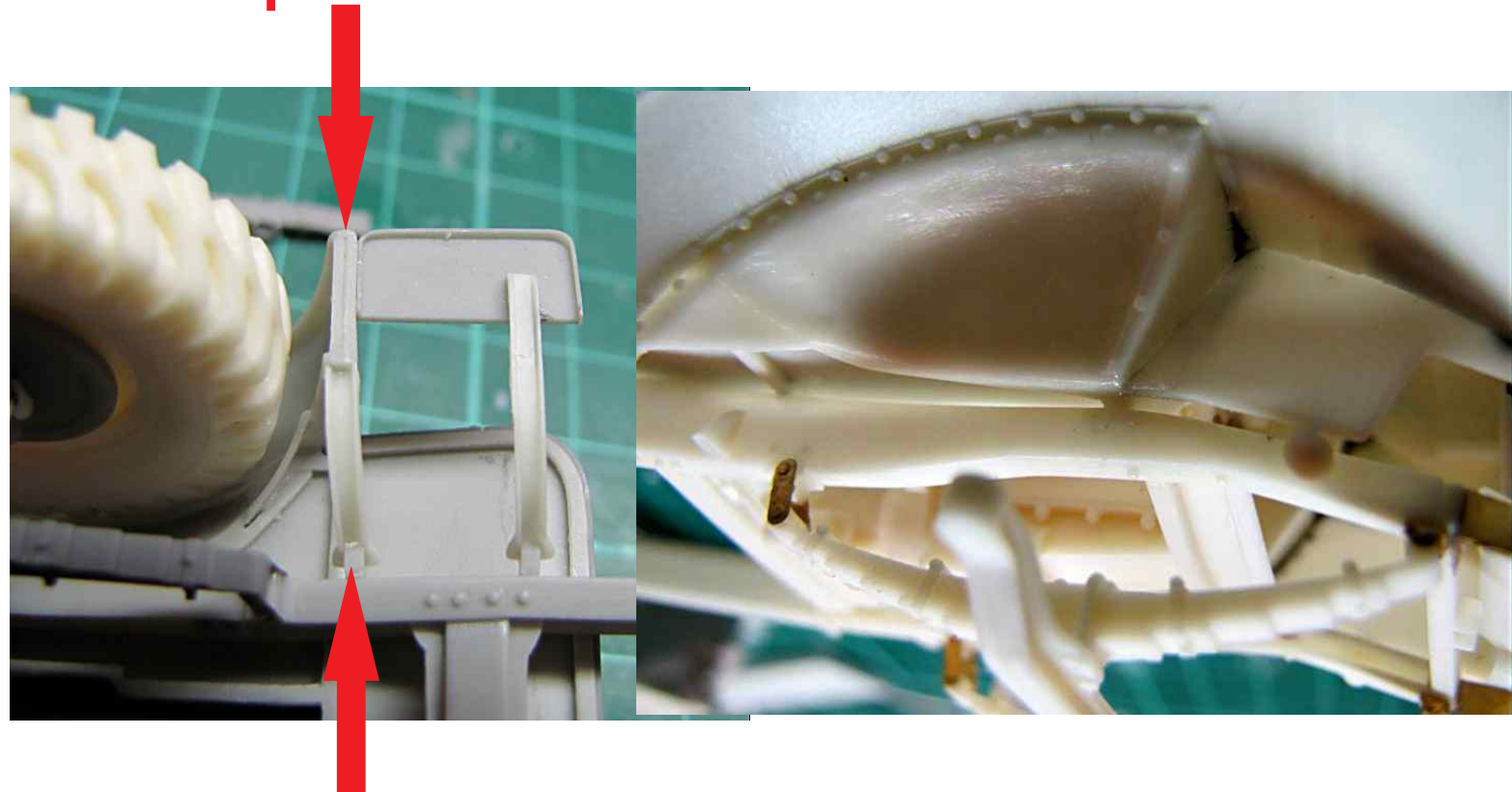

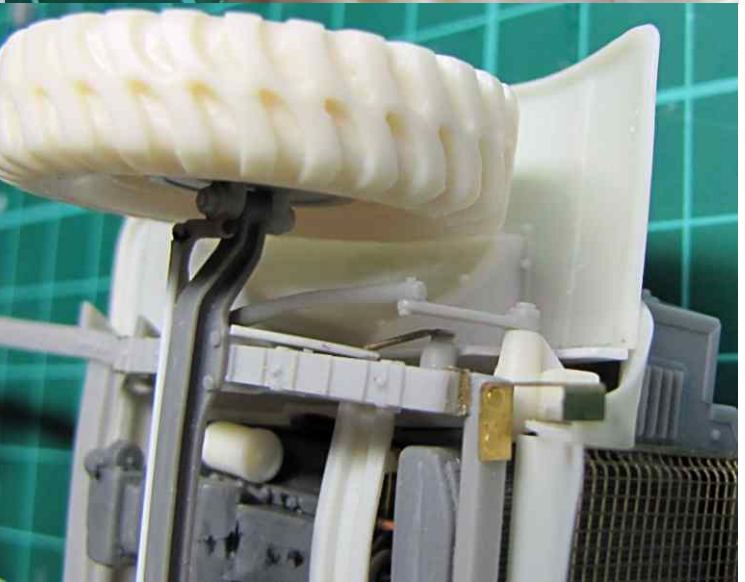
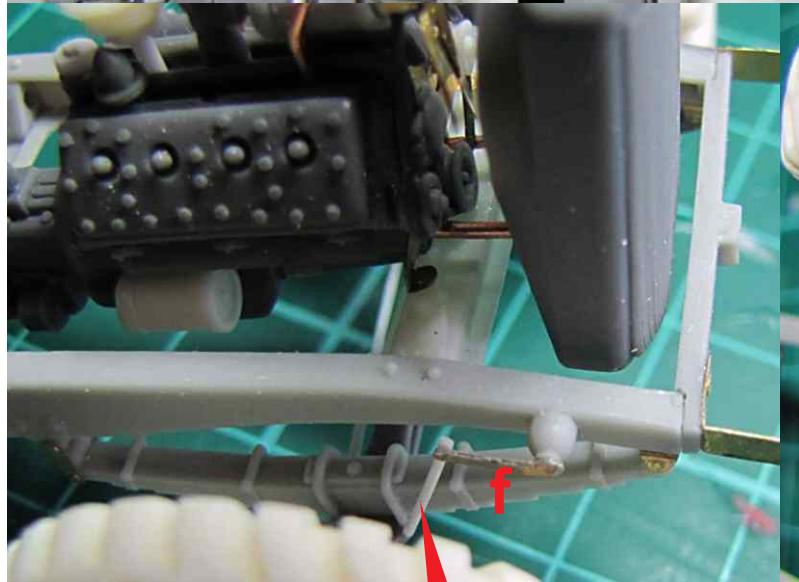
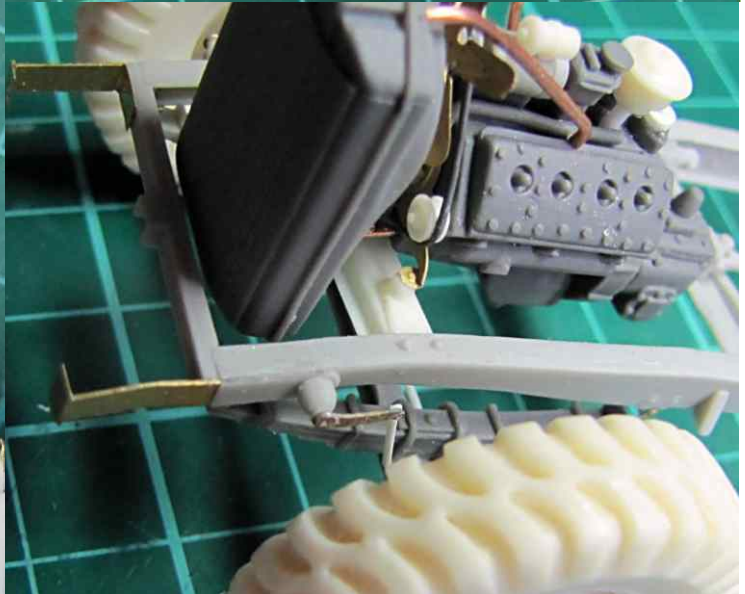
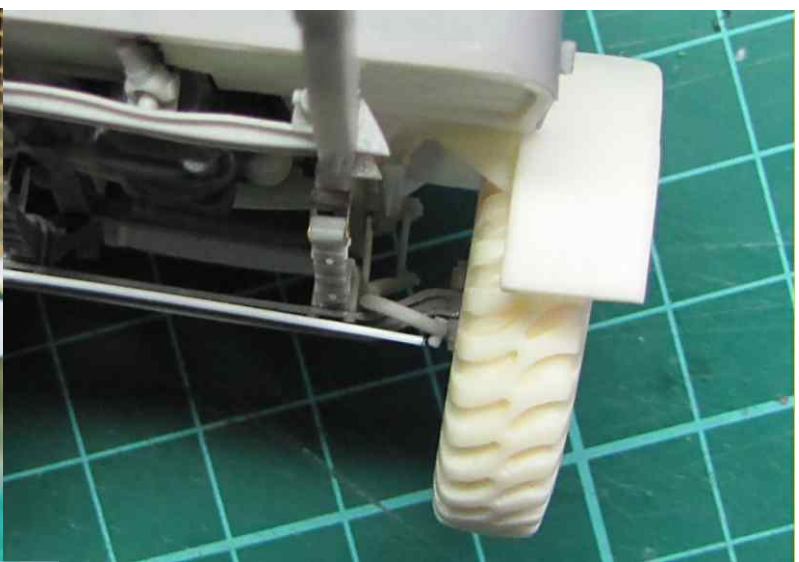
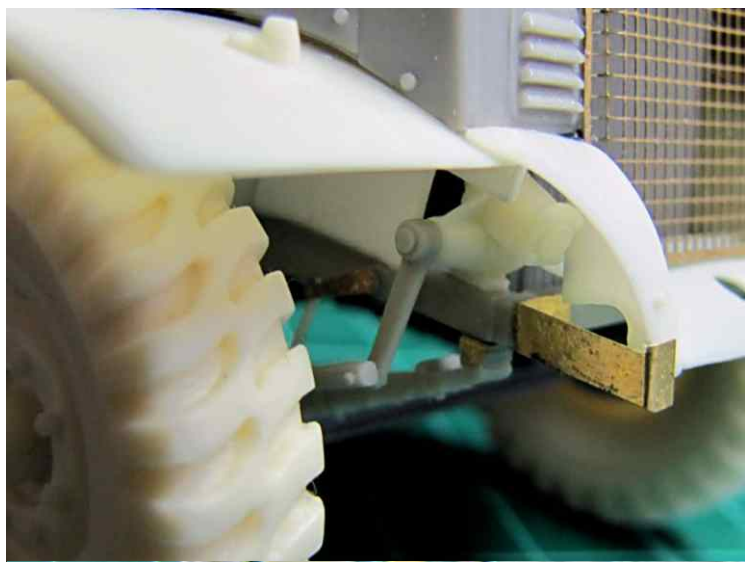

0,5mm wire

f - glue two bits together
(one flat, one with design)



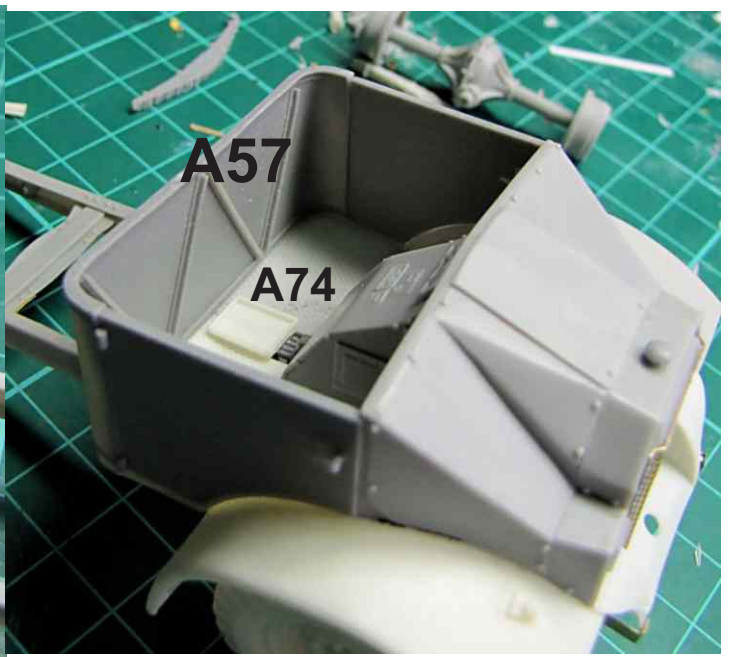
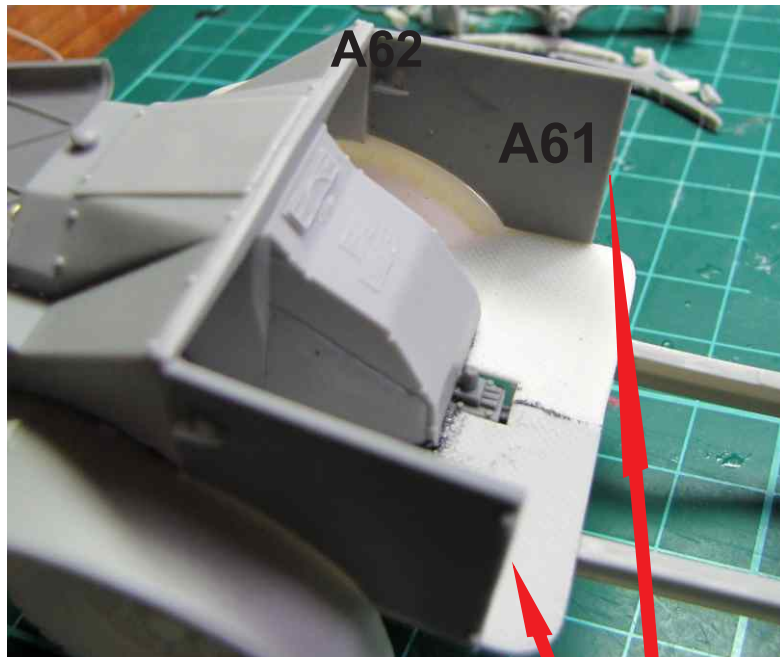
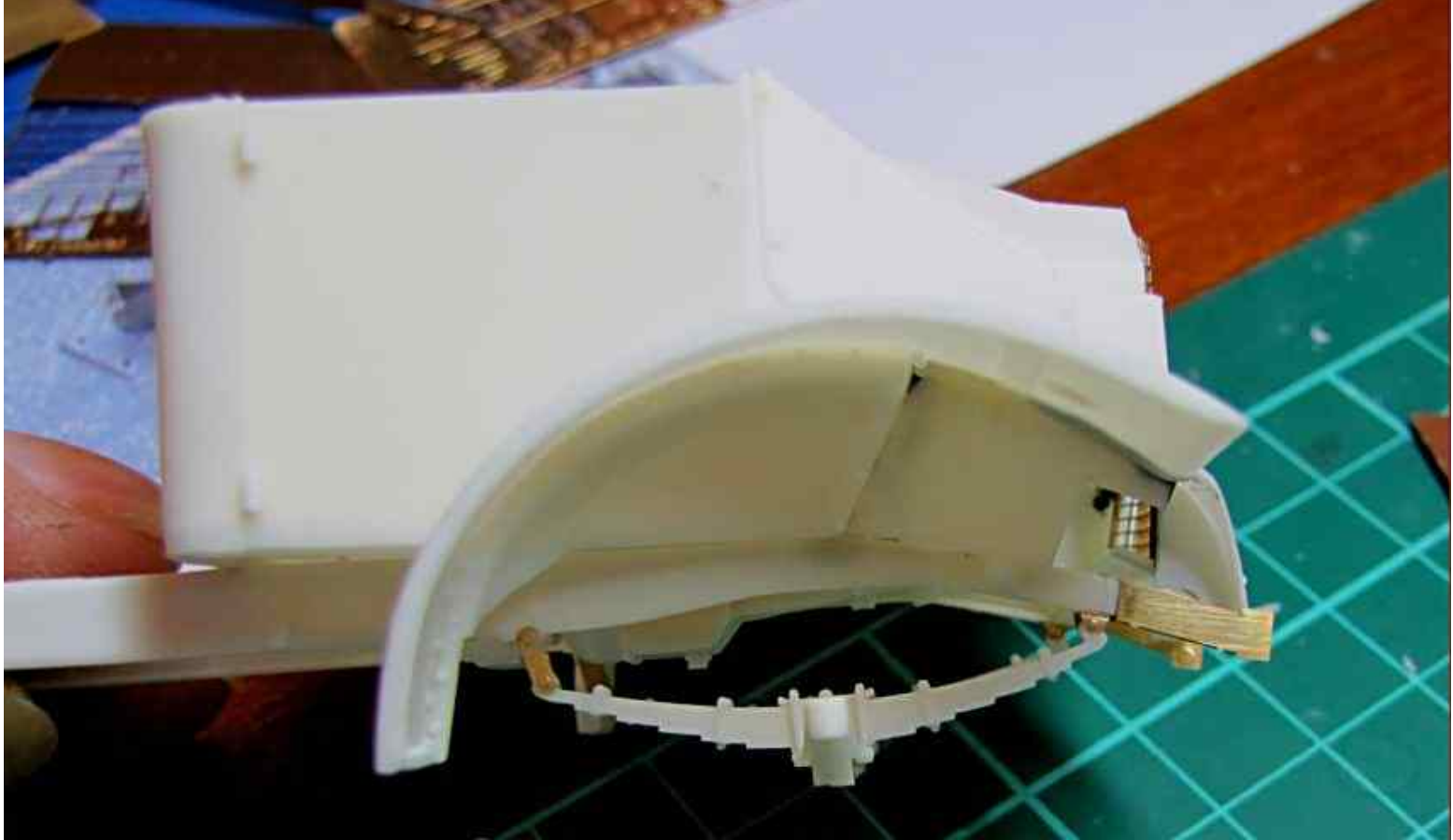

**Assemble one door first,
then the back wall
and finally second door
to make sure they will fit
If doors go in tightly, sand
lightly the edges with
hinges**

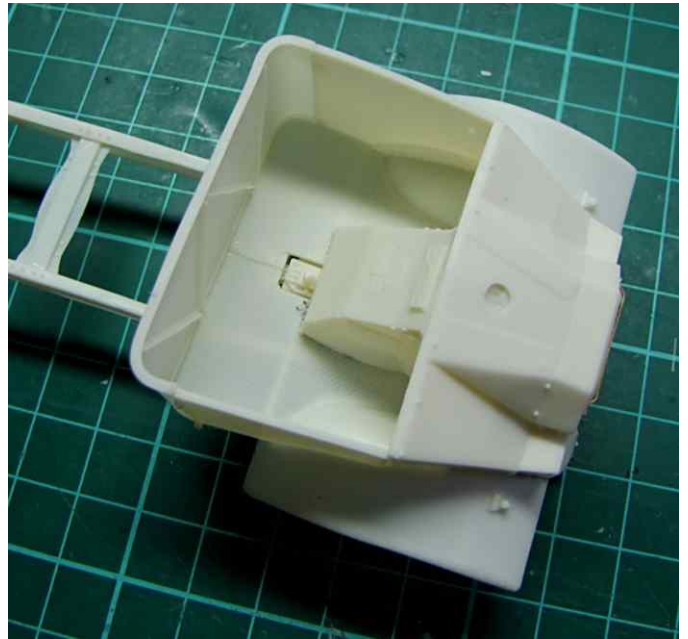

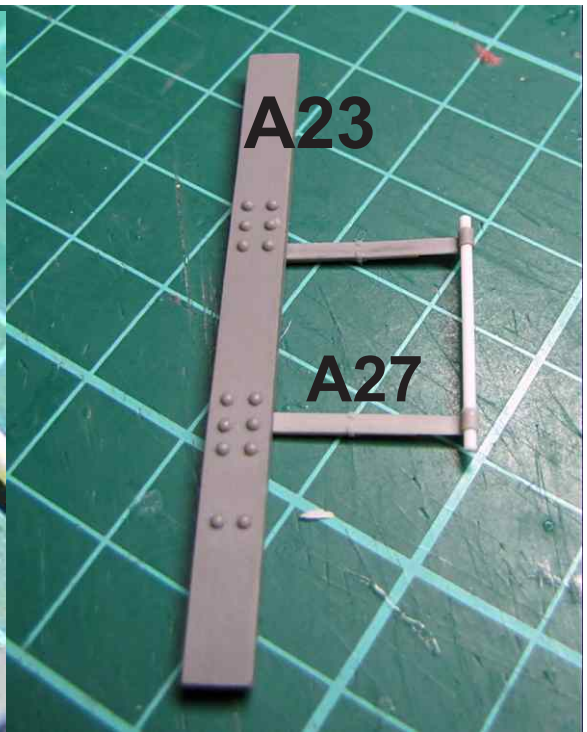
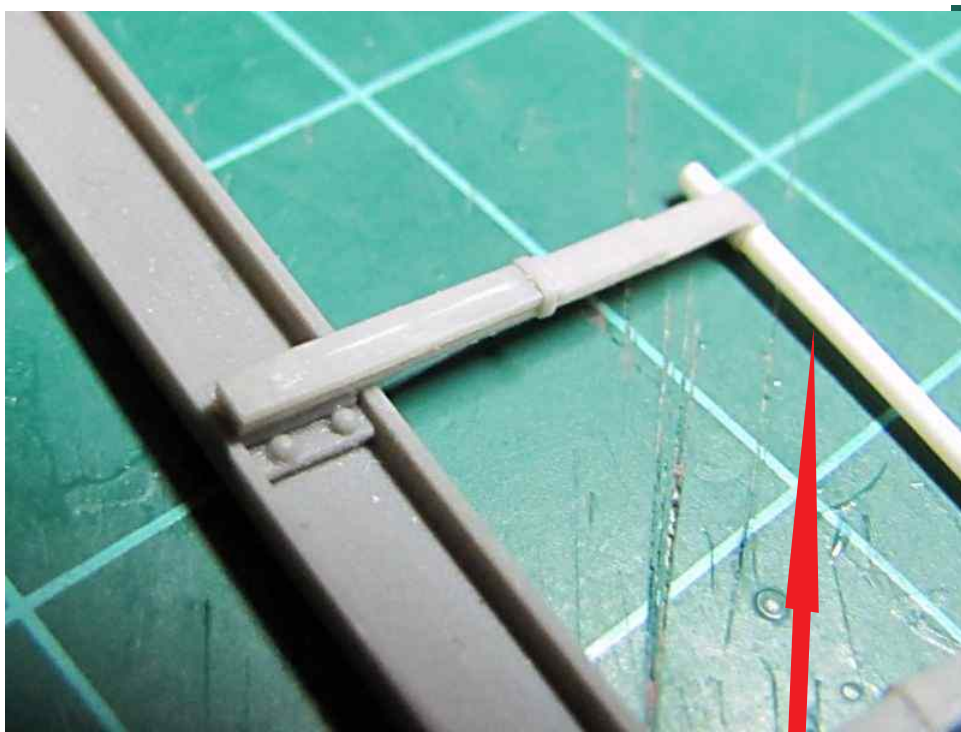

0,8mm wire

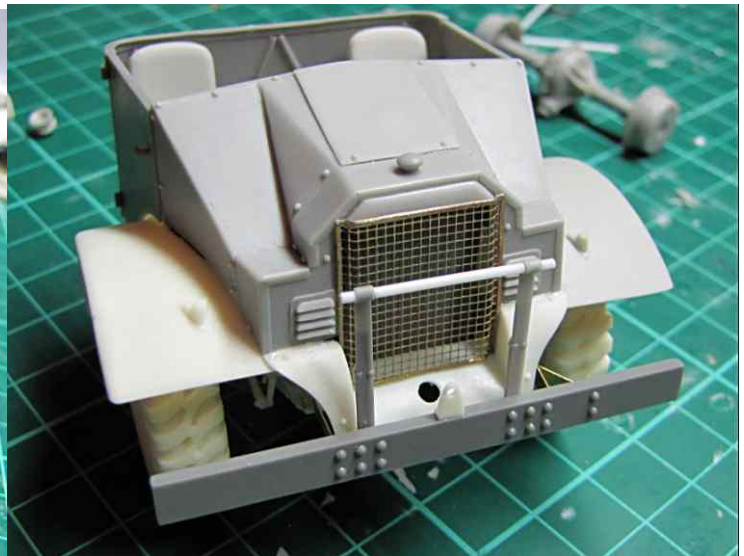
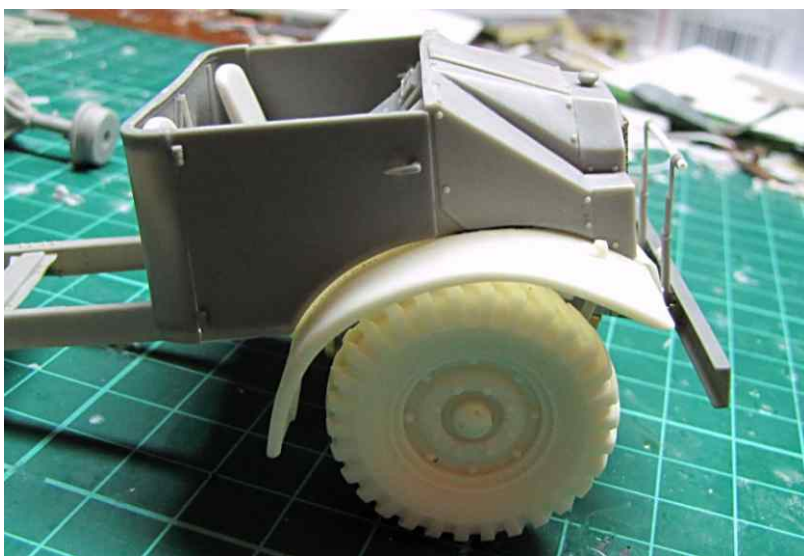

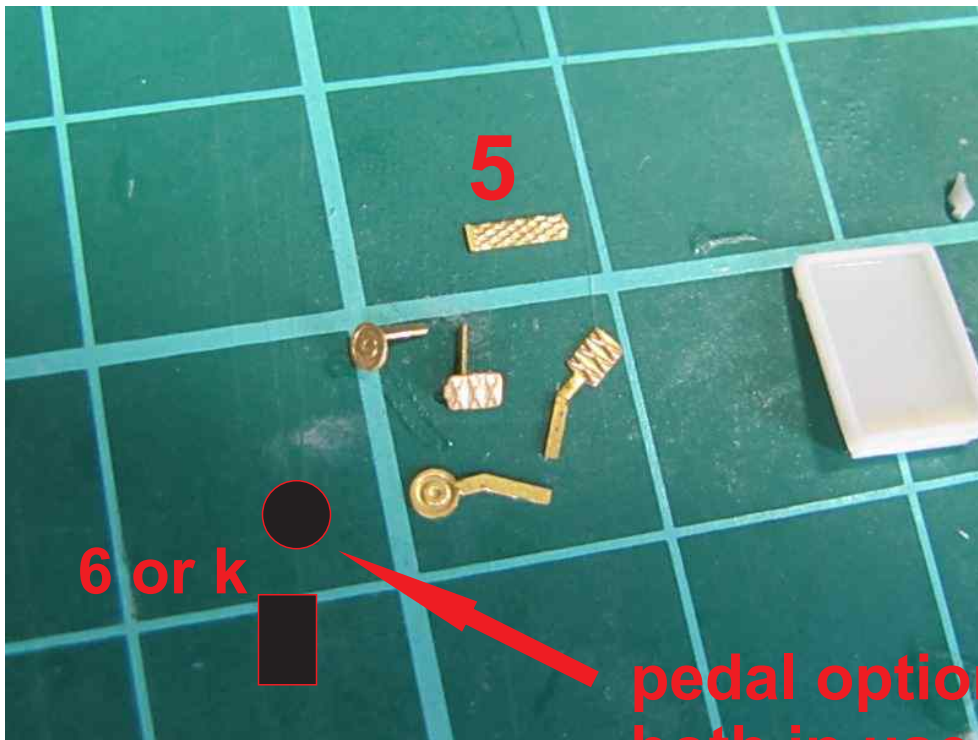

pedal options, there were both in use



0,5mm wire

strip of PE frame + bit of wire for handle



drilled hole 1,2mm for easier assembly of steering wheel

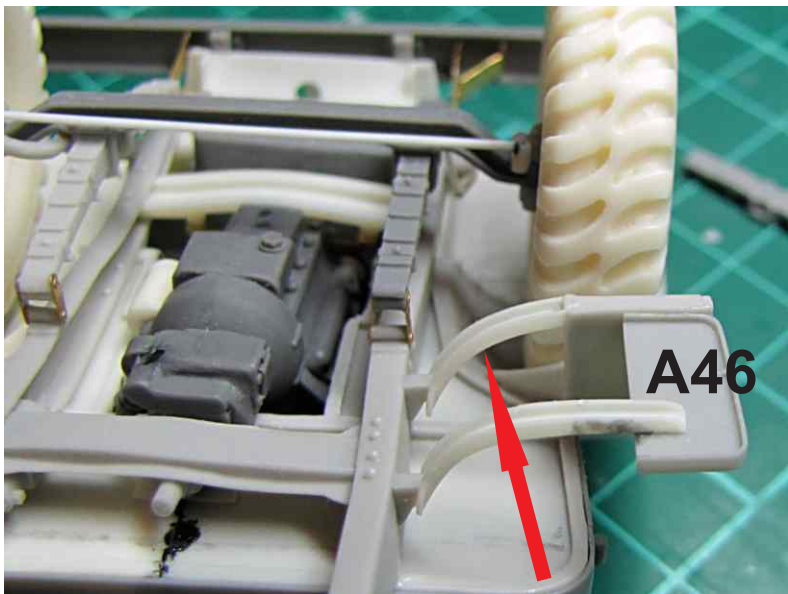

**cut step board holder on length required
2 next to front wheels, connected to mudguards
shape them more with use of hot water, if necessary**



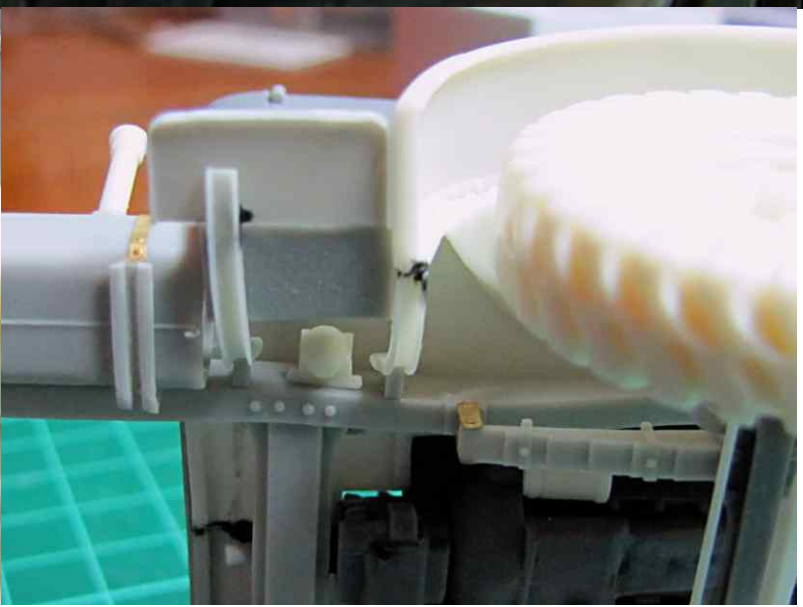
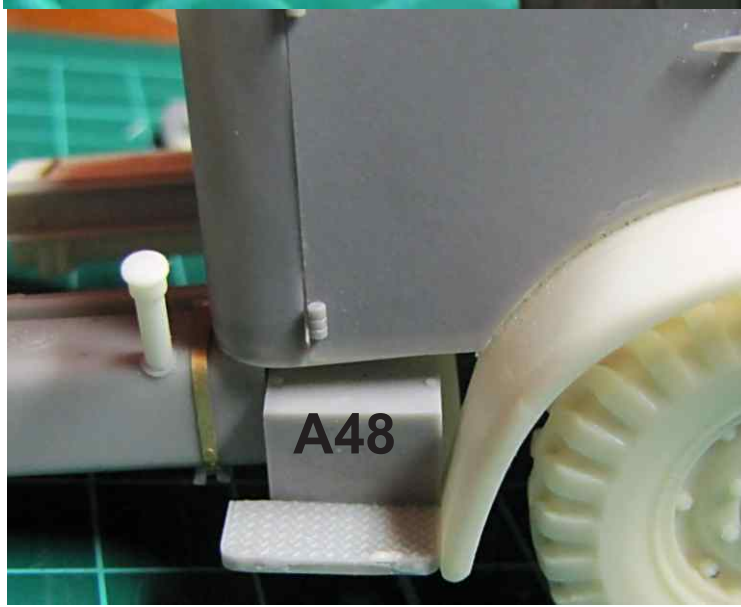
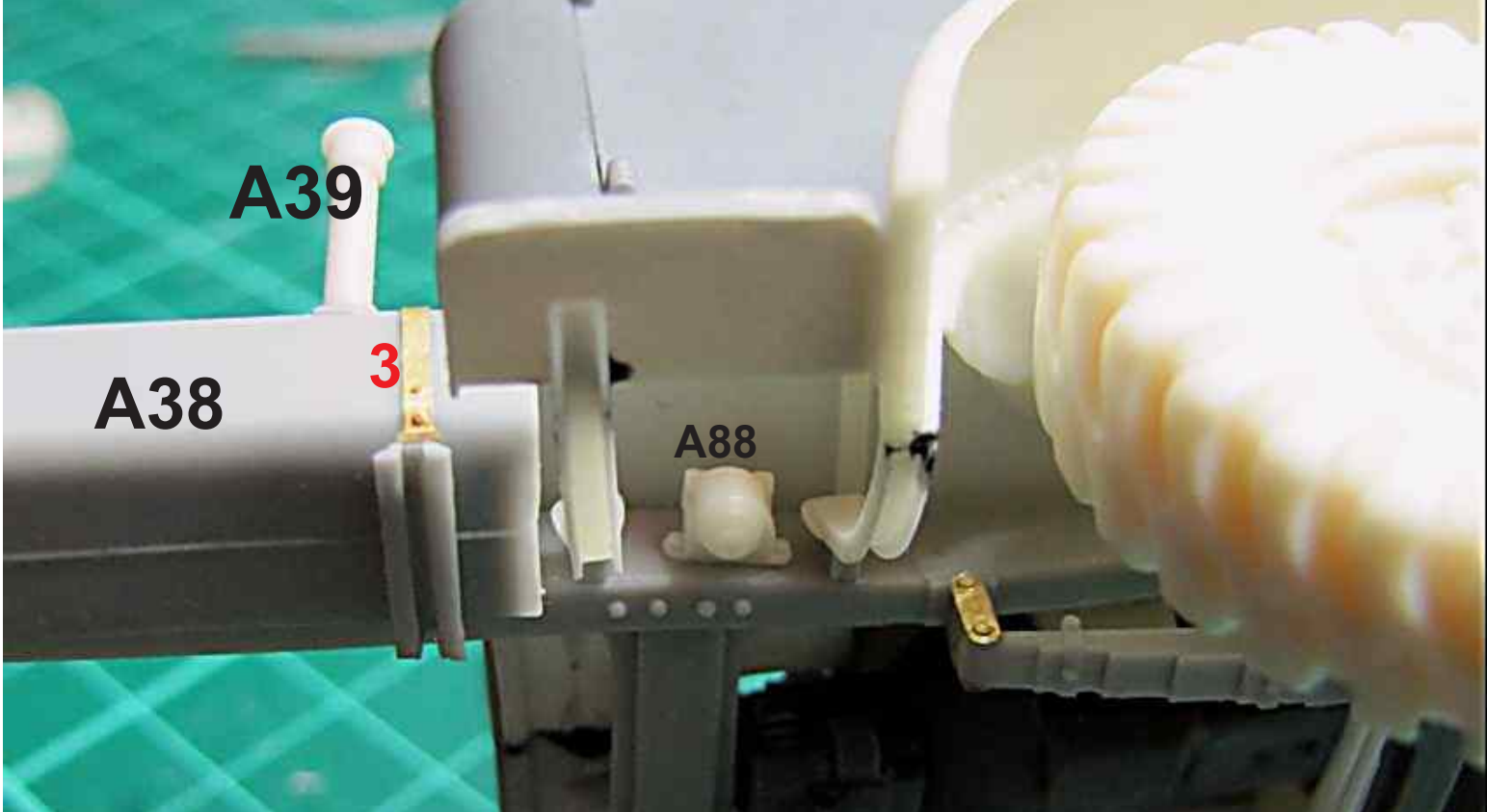

For additional details fuel pipe can be connected to the filter, and tiny wire used to connect the battery

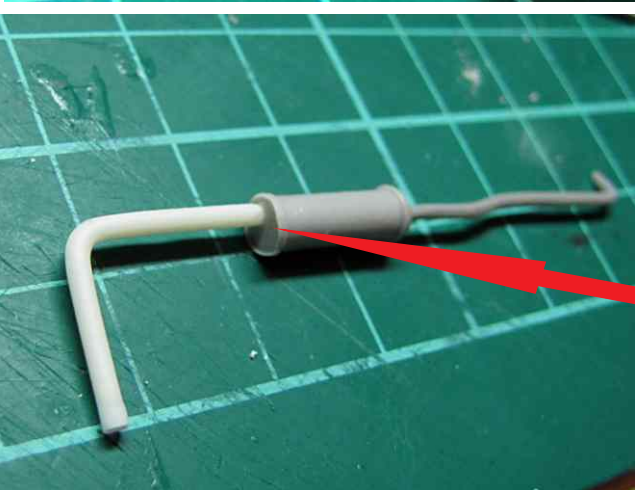
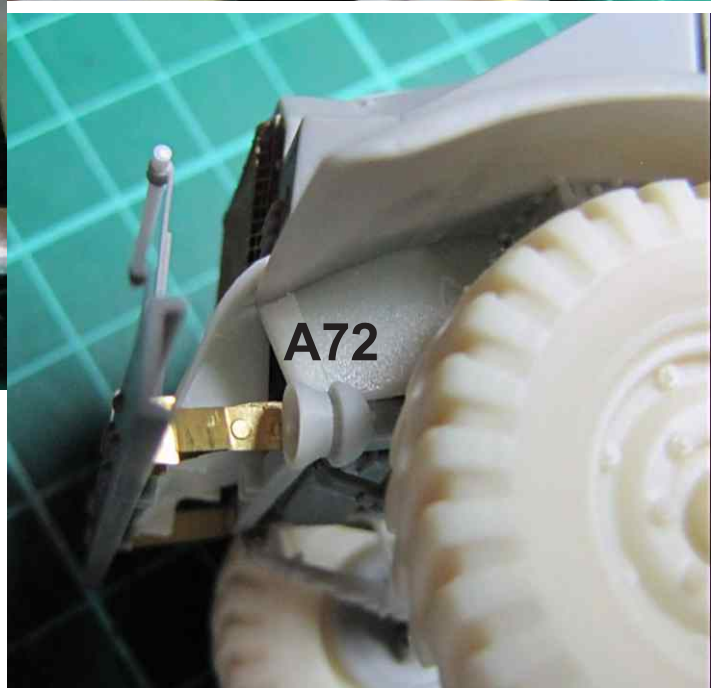
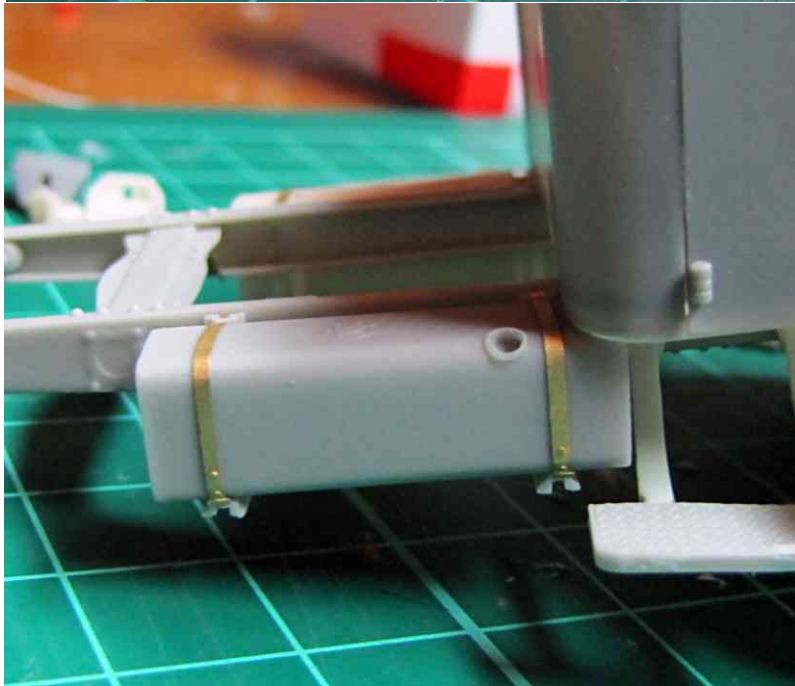
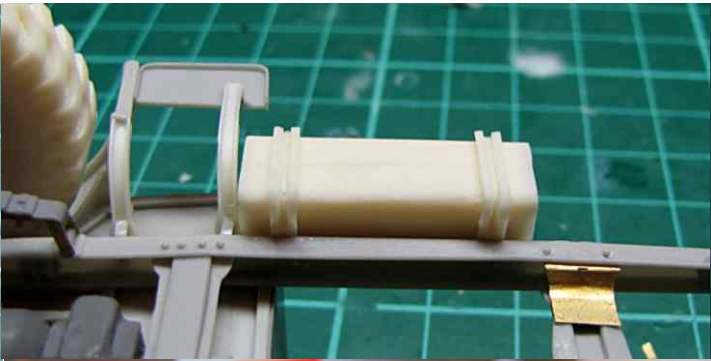

mind correct position

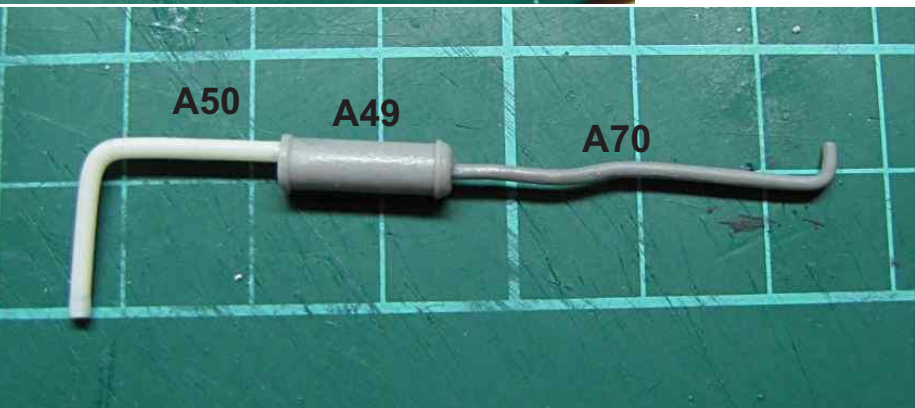

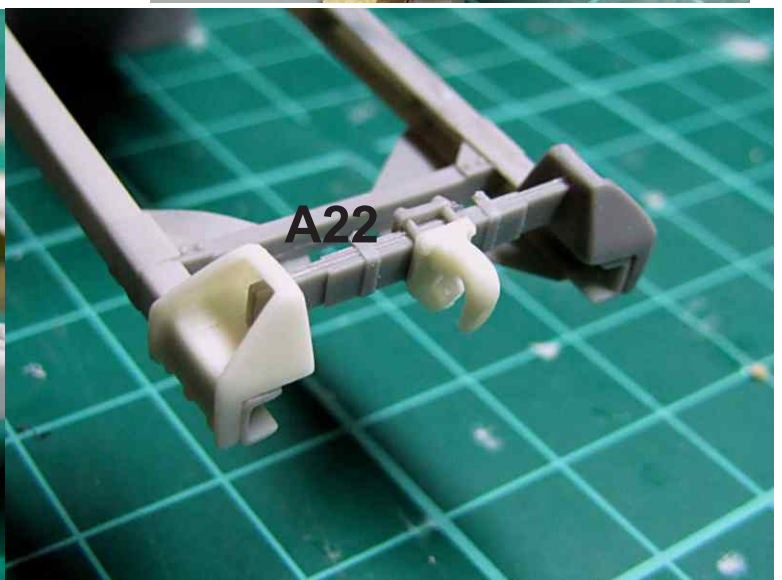
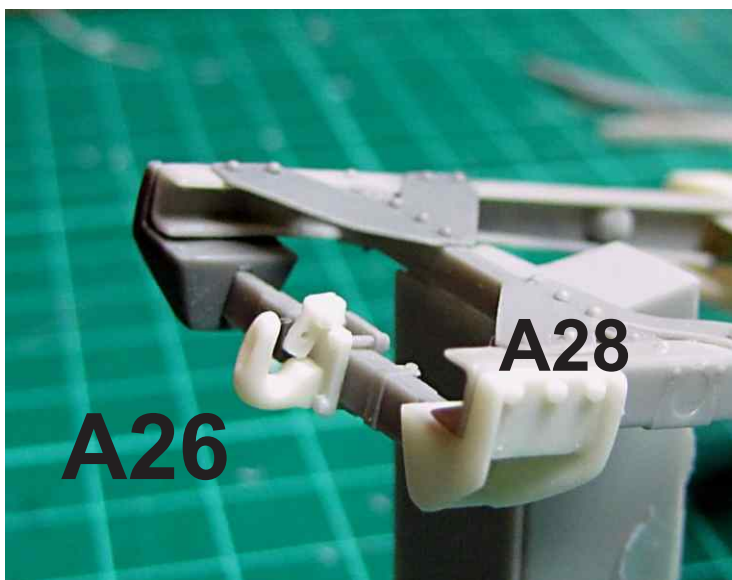
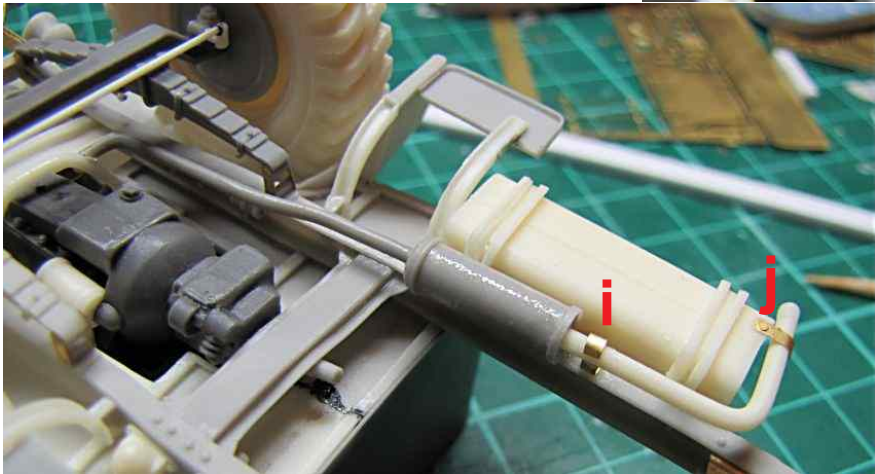
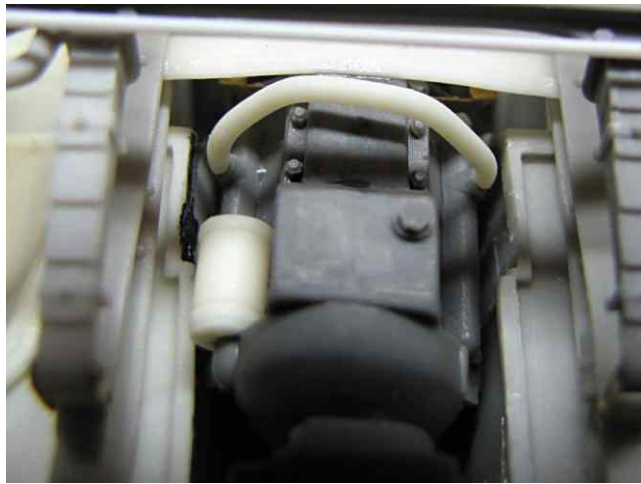

mind correct position

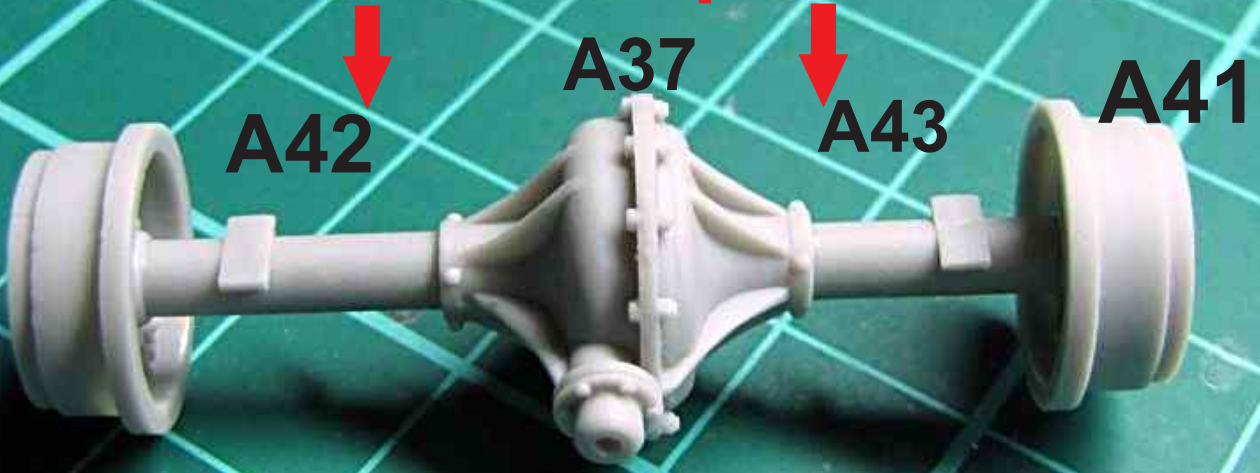

to front



top

mind correct position



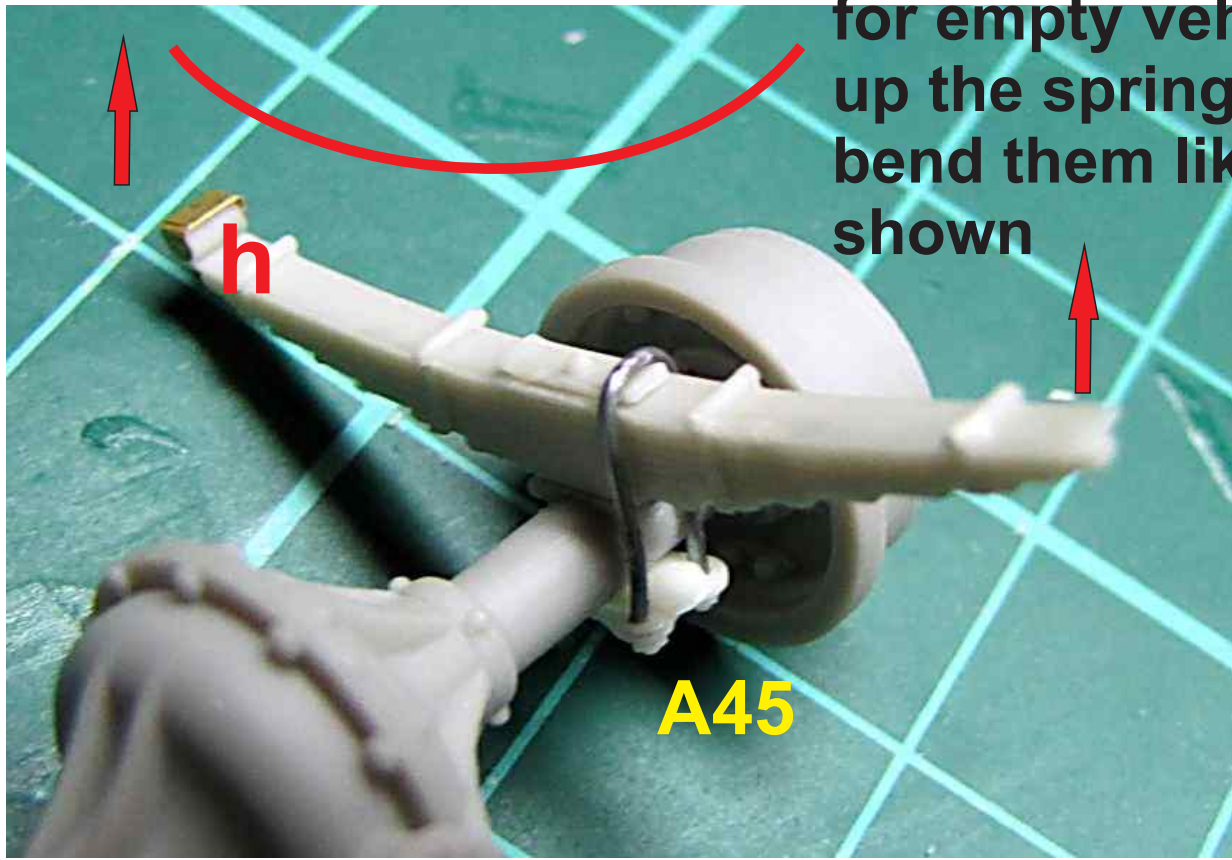

for empty vehicle warm up the springs and bend them like shown

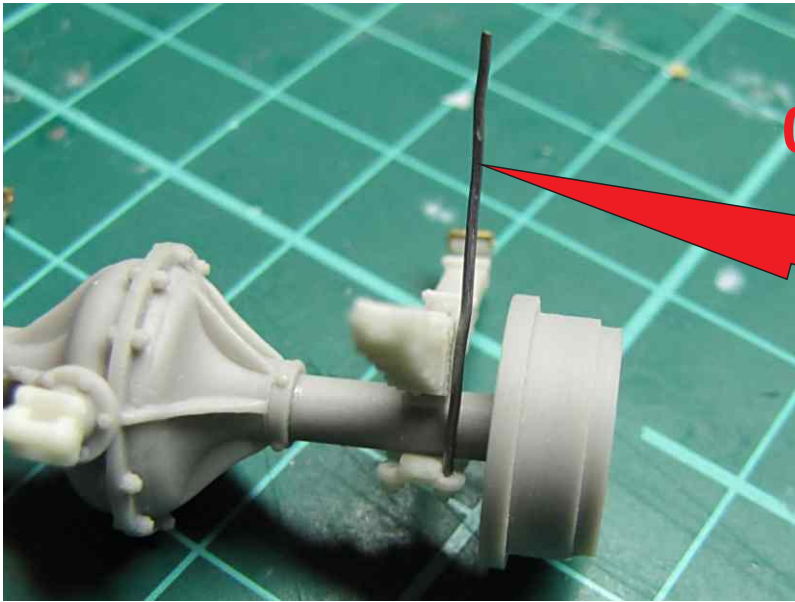

0,5mm wire



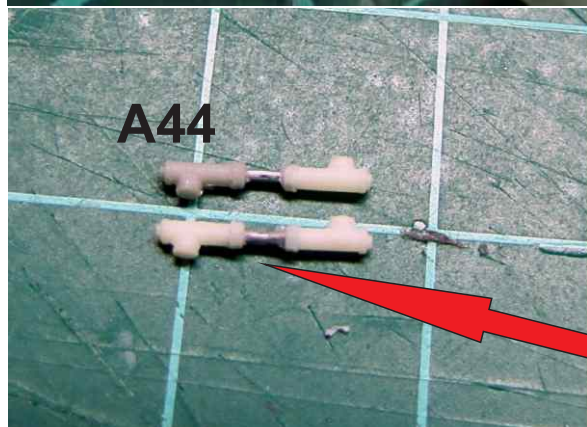
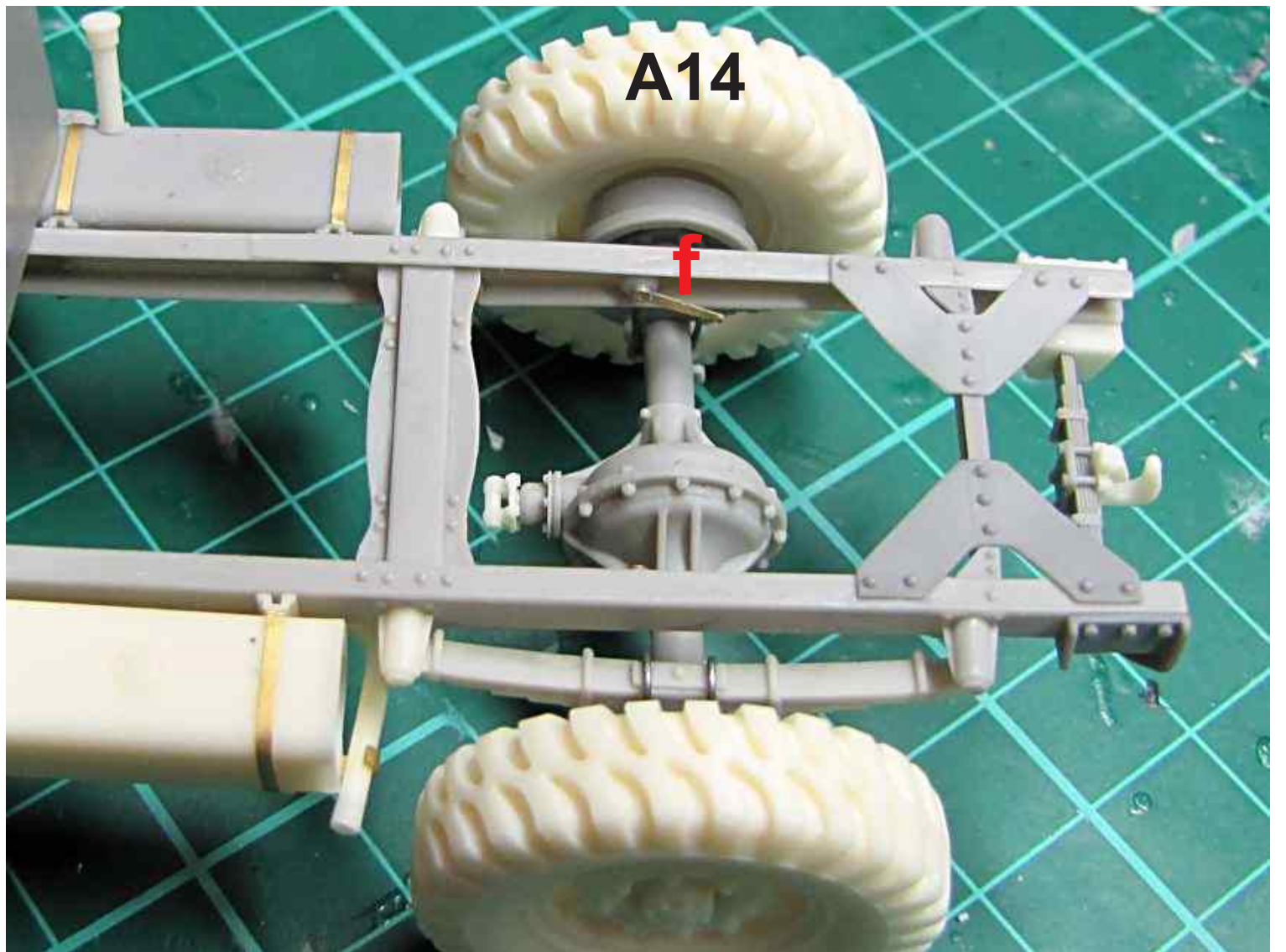

**you can drill 0,5mm holes
for easier assembly
0,5mm wire, 3mm long**

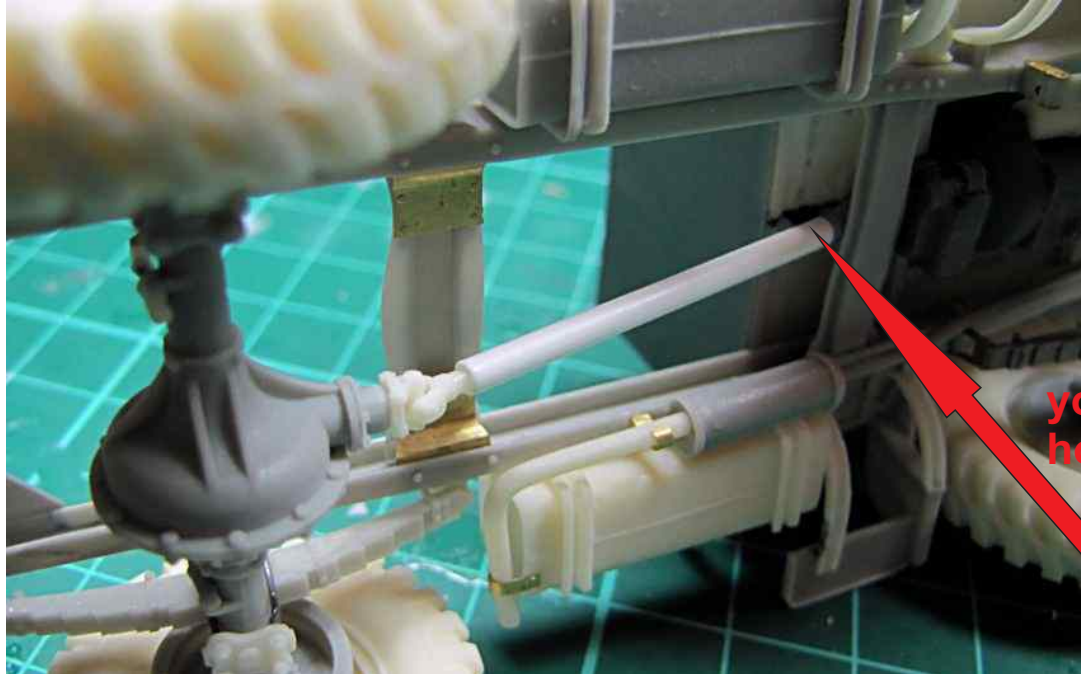
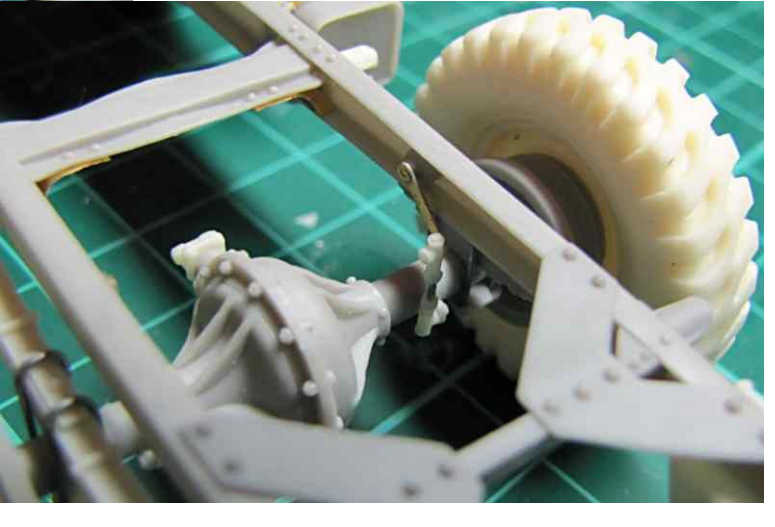
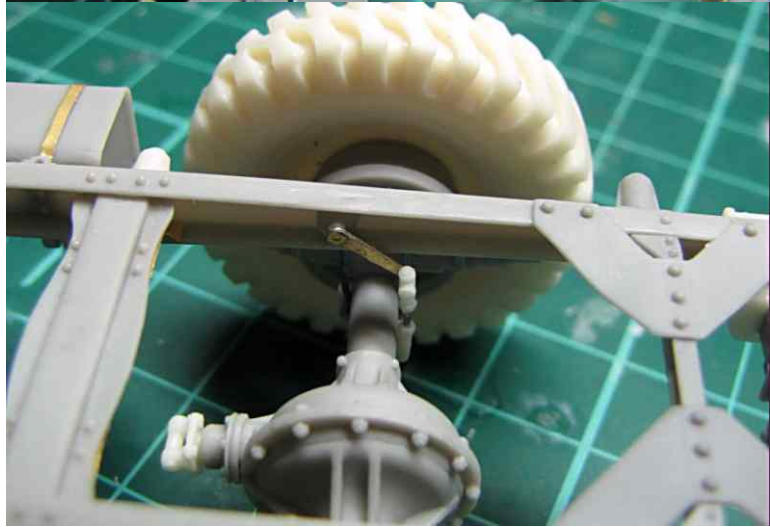
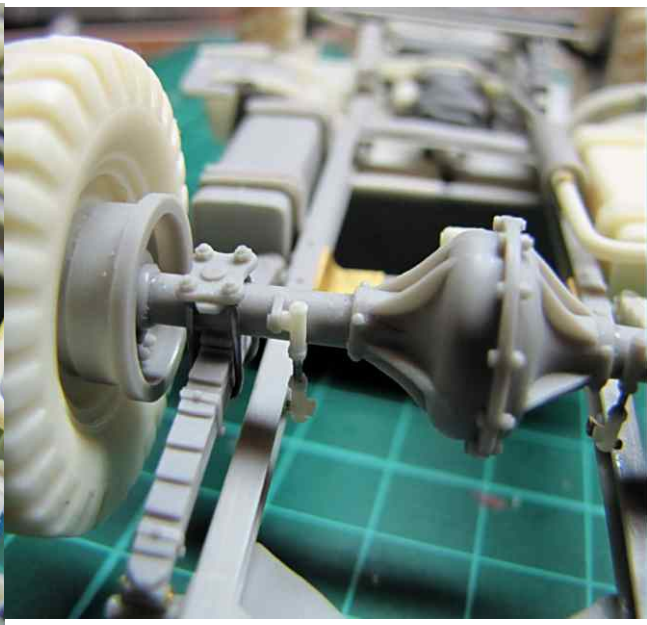
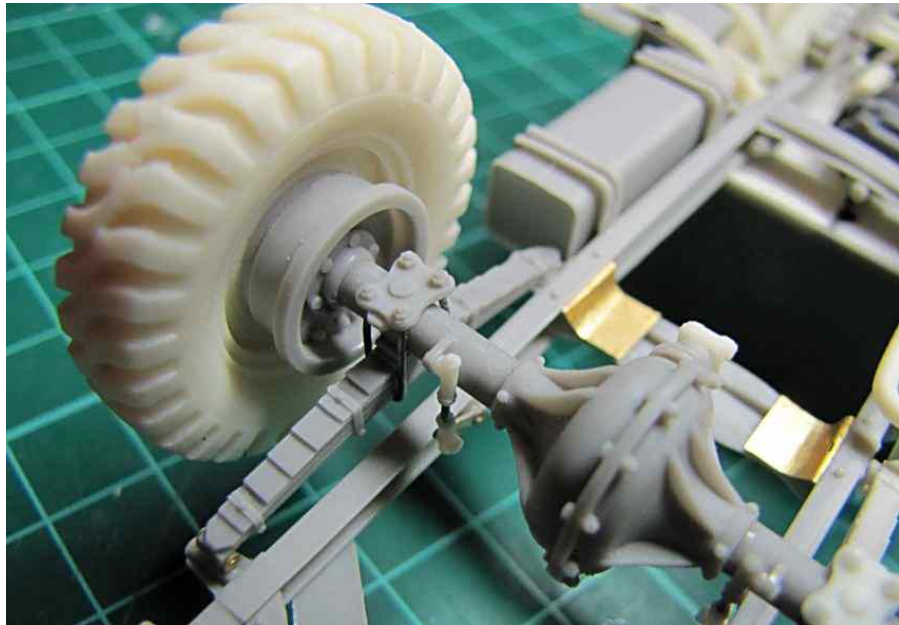

you can drill 1 mm hole for easier assembly

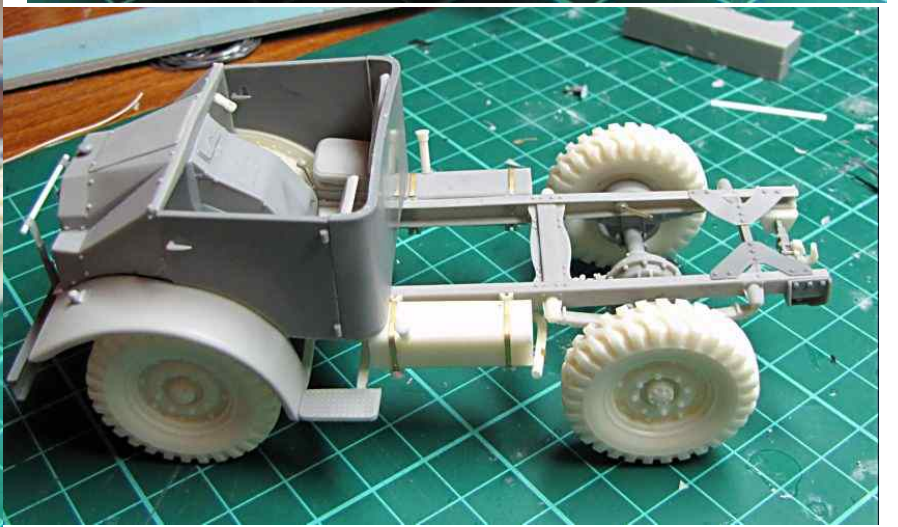
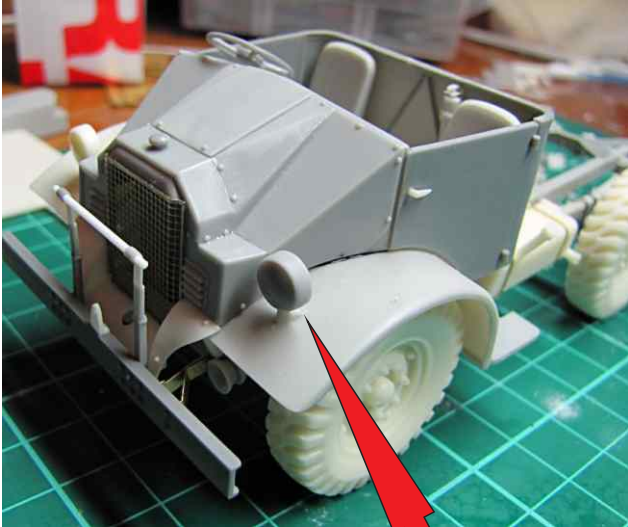
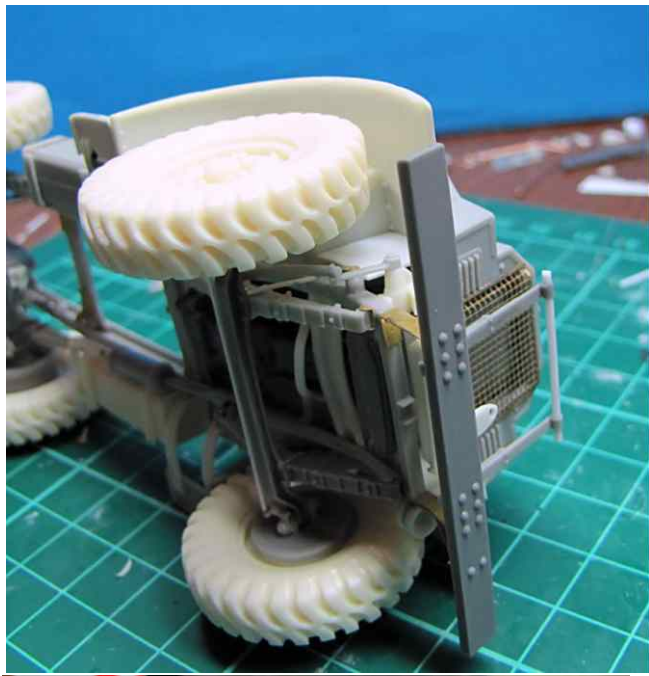

clear resin lights

1,2mm rod

A67

A65

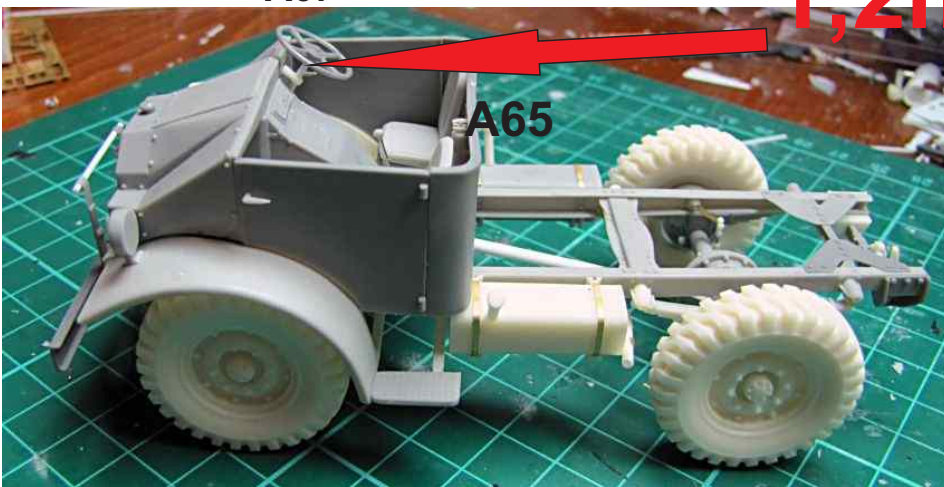

body assembly

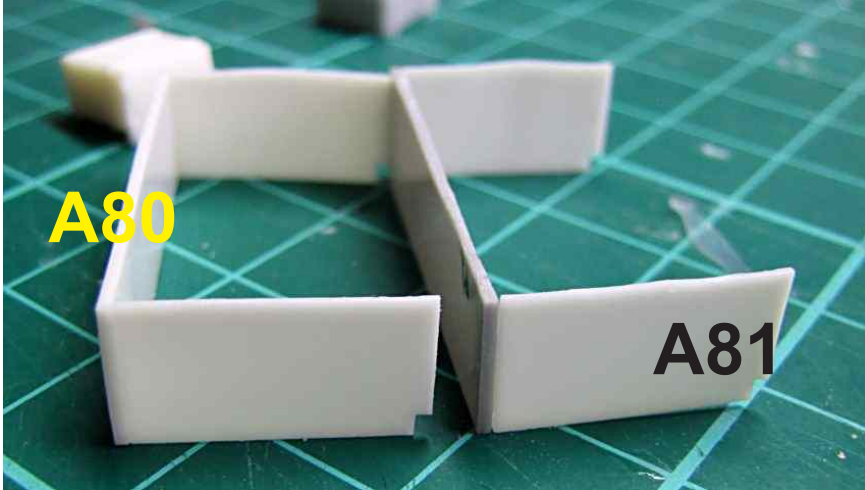
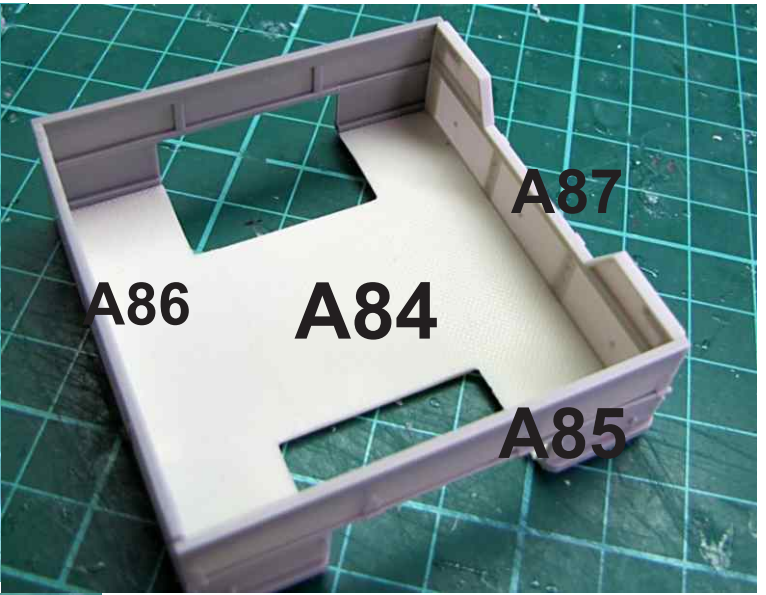
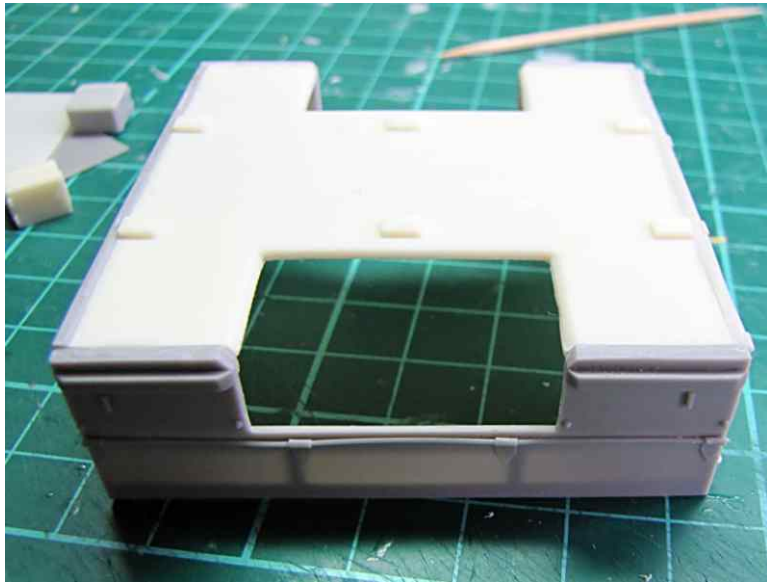

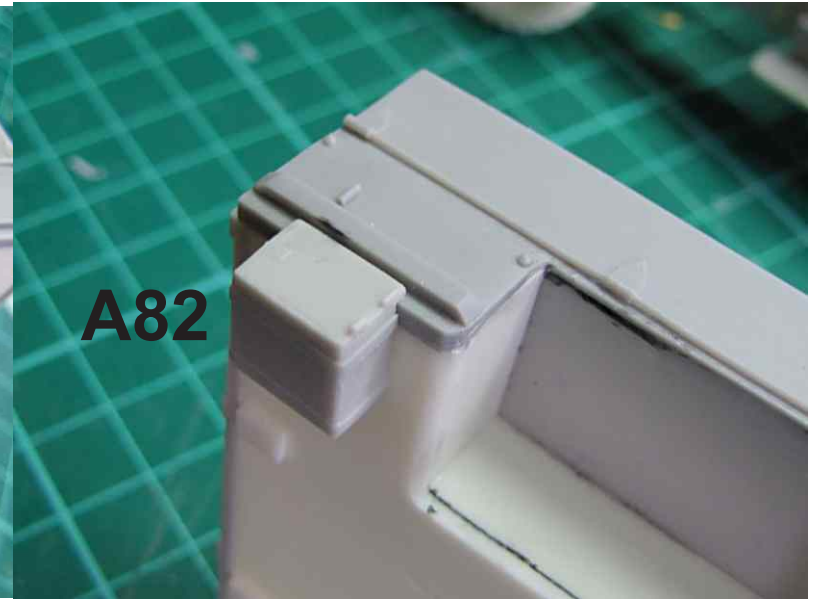
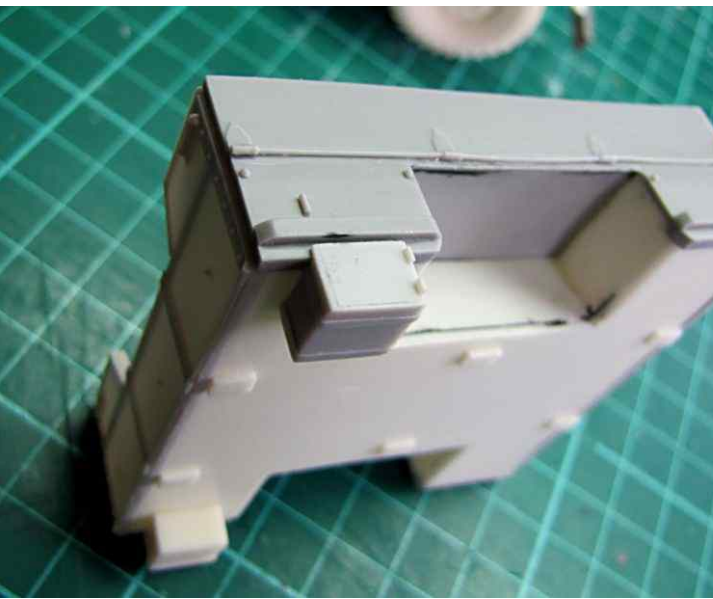
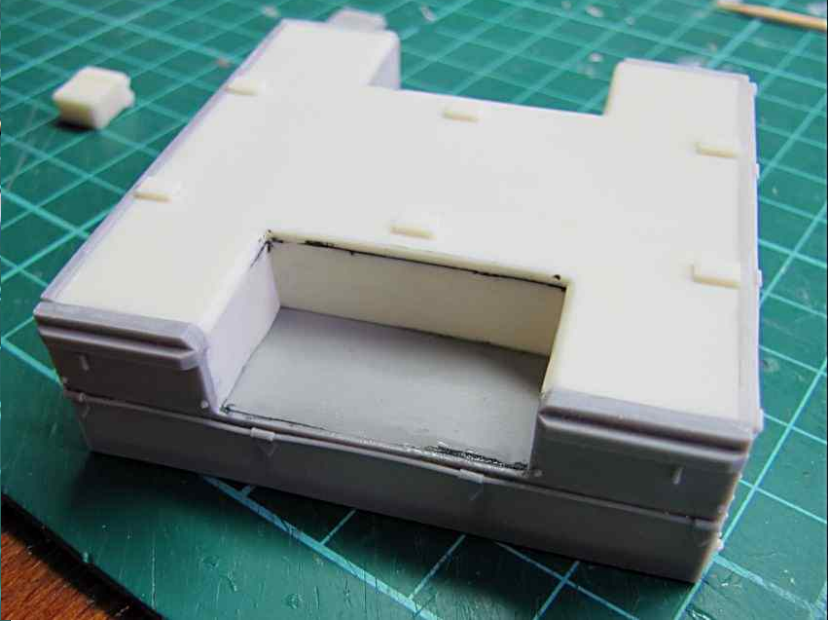
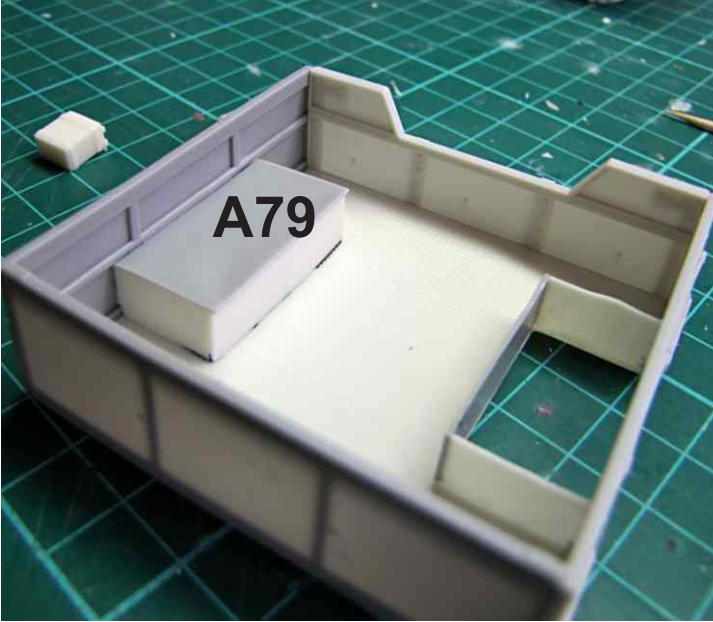



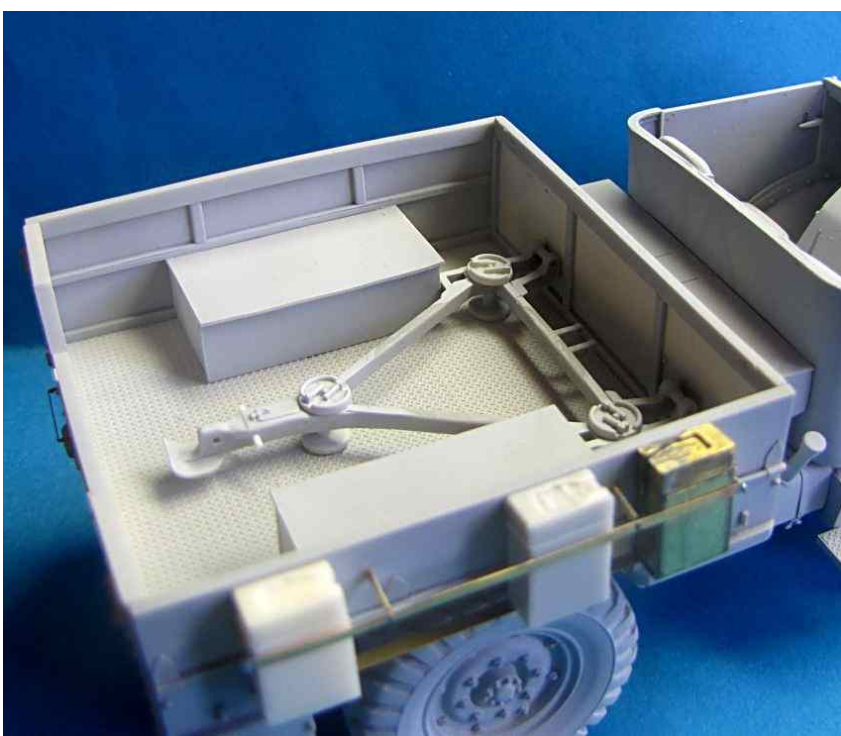

**to mount Flak inside,
do not glue its turntable,
but put the Flak base into
first, and then add
the rest of the Flak on its
base frame**





Painting and decal placing example

1/35 German Flak 30 gun

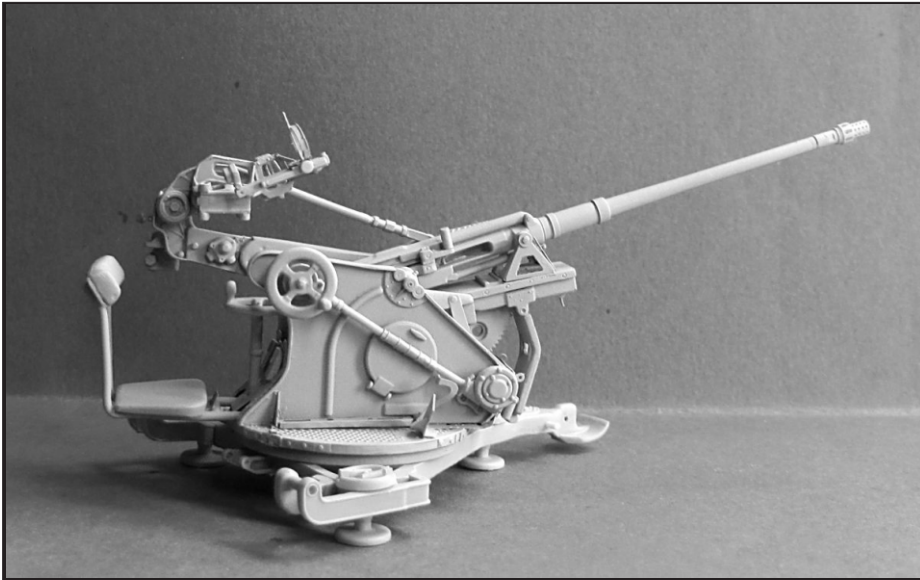

contains 1 highly detailed and accurate model

40 resin parts

**40 PE parts, turned metal gun barrel
included 3 ammo boxes**

+ plastic parts and wires needed for assembly
glue and paints not included
suitable for average modellers

keep safety rules for work with resin
instructions and references on CD



No.35413

WWW.LZmodels.com

Made in EU

Keep safety rules when working with resin.

**For safety reasons, and due to the complexity of construction,
this kit is recommended only for advanced modellers.**

**The kit contains small parts, keep it out of the reach of children.
Glue and paints not included**

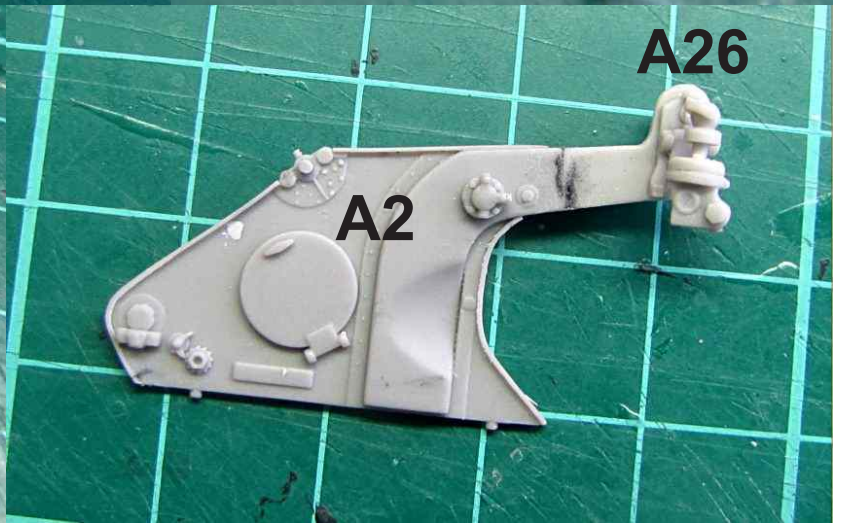
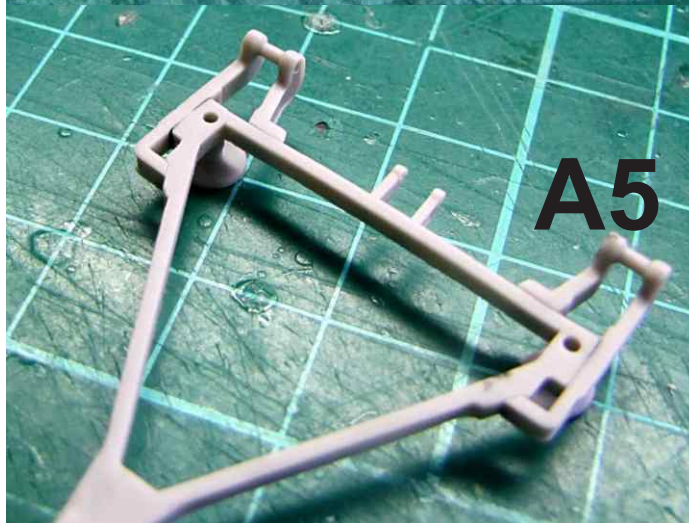
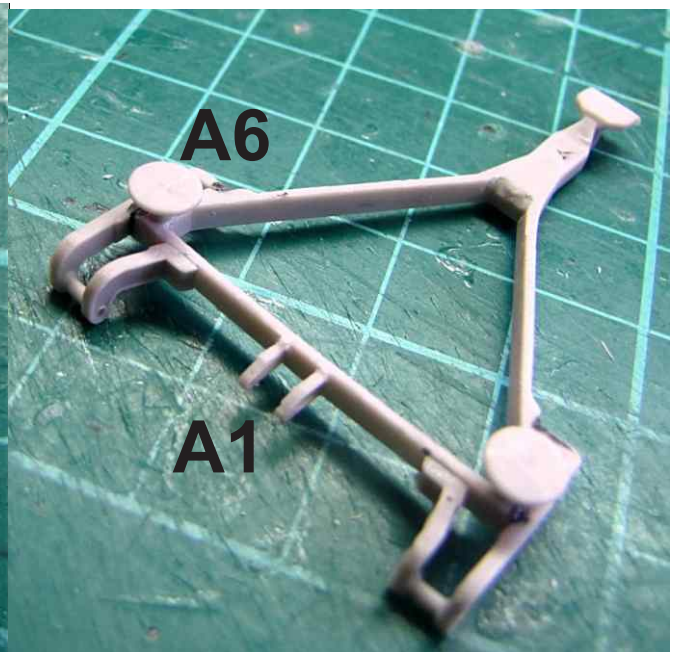
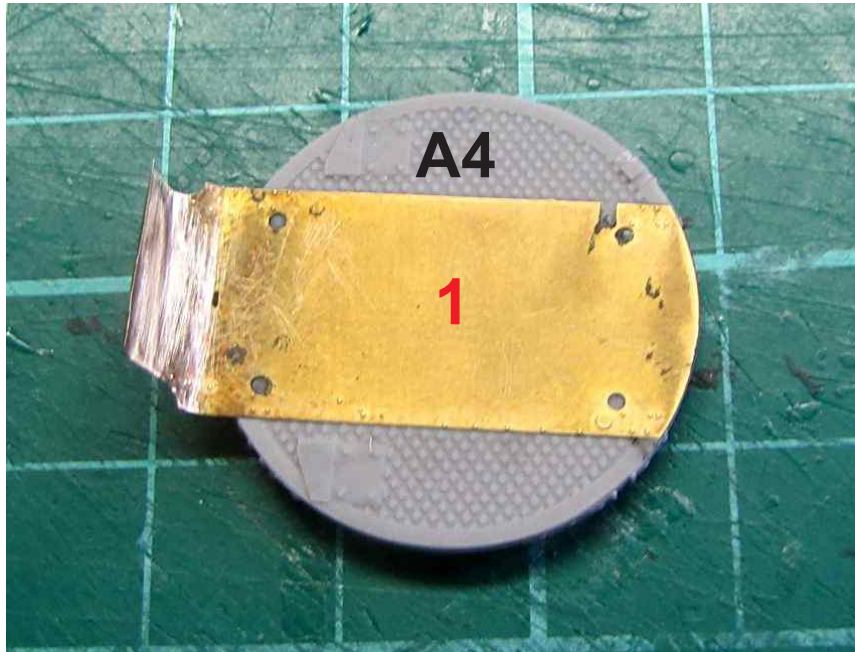

Drill through or adjust holes wherever needed

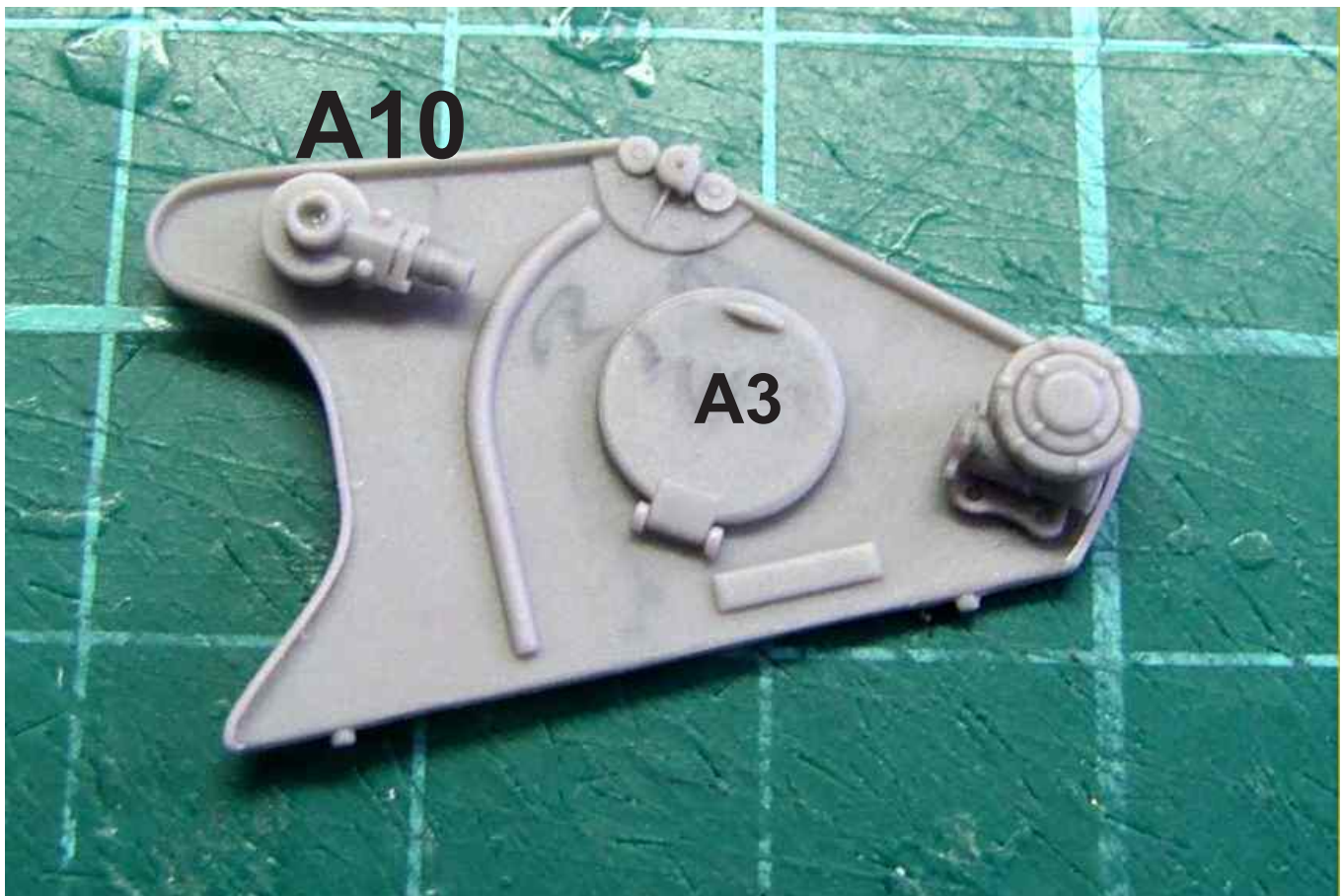



push rivets marked from the back, for easier work
cut part in two pieces, and then glue - solder

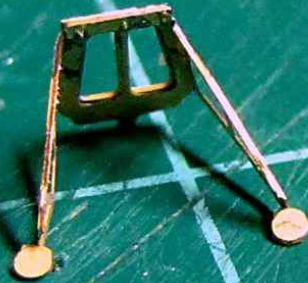

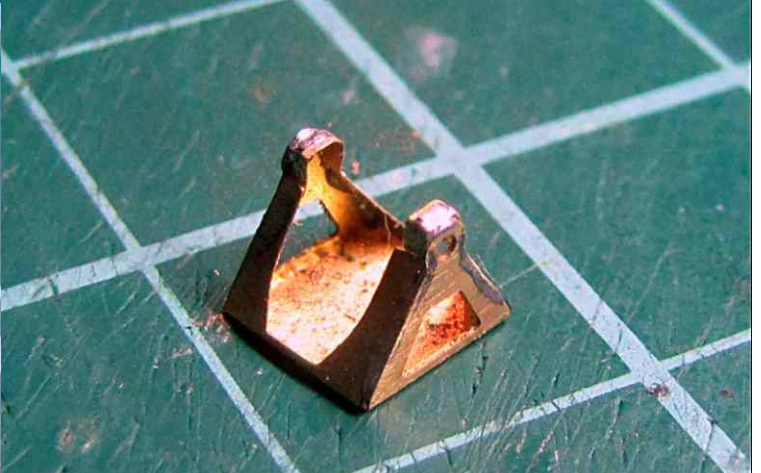
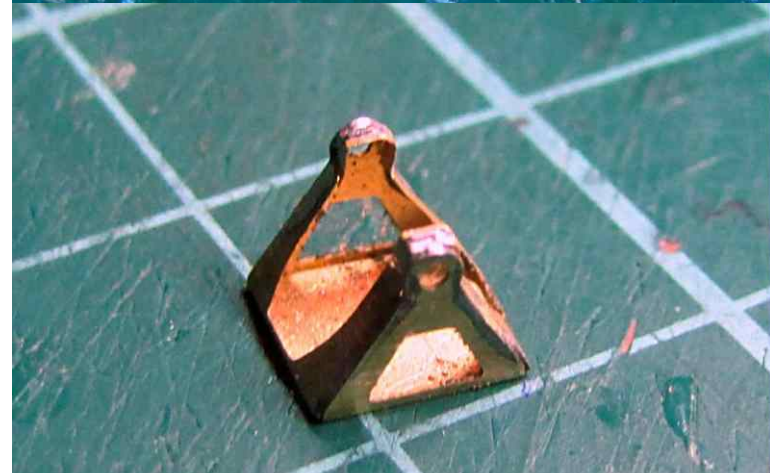
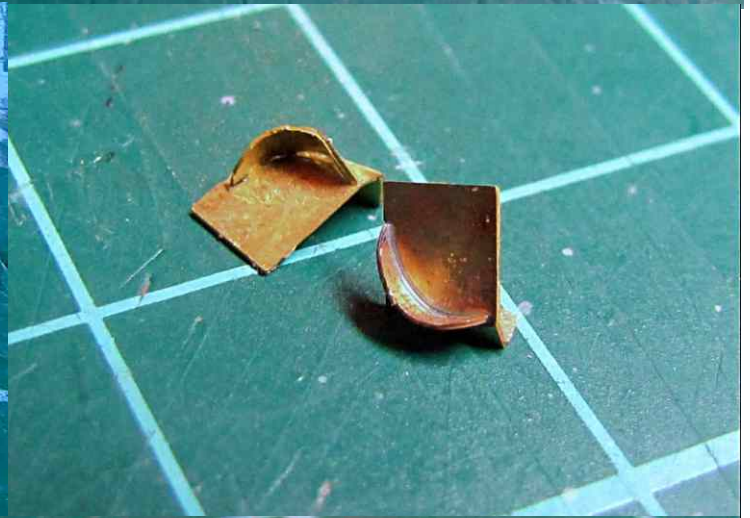
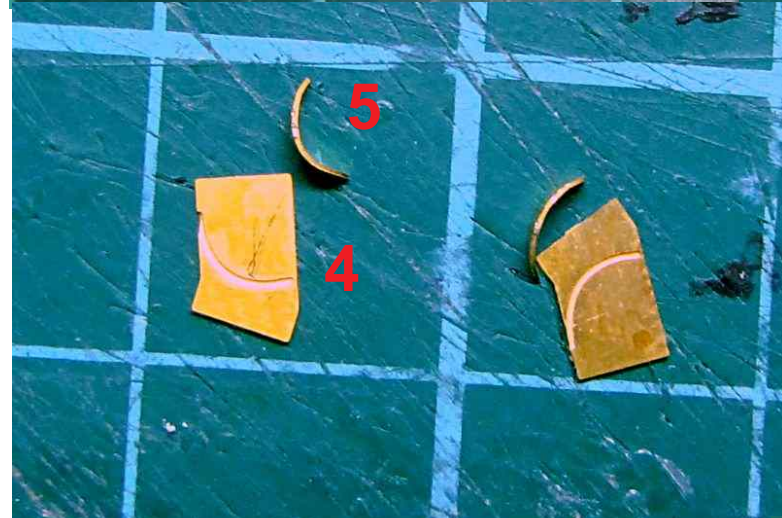
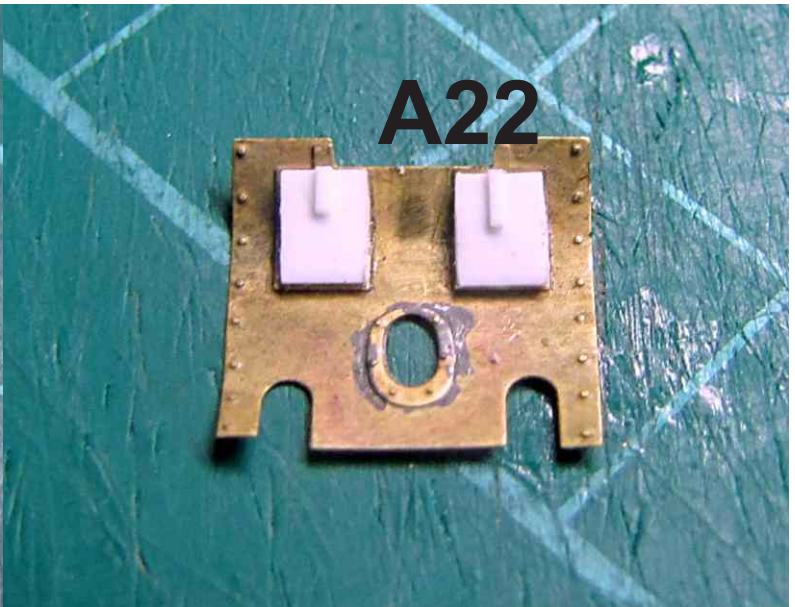

slots vertically down

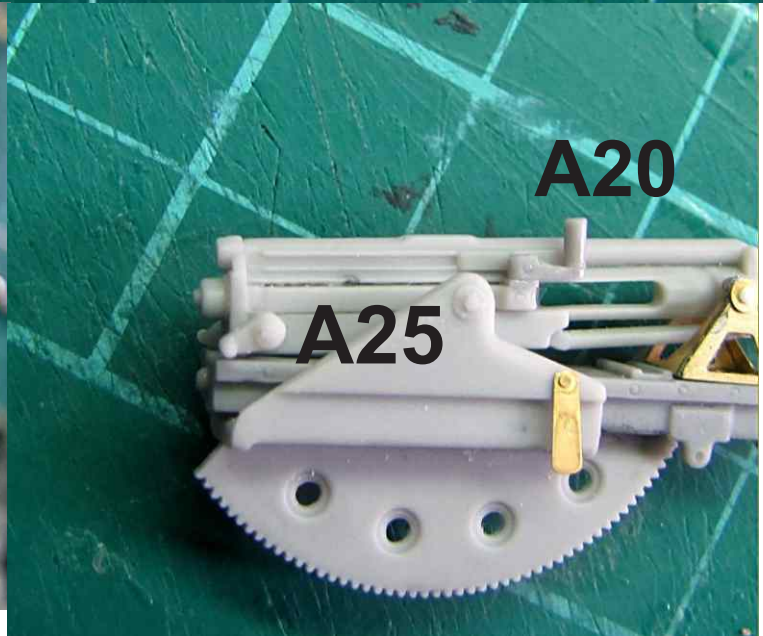
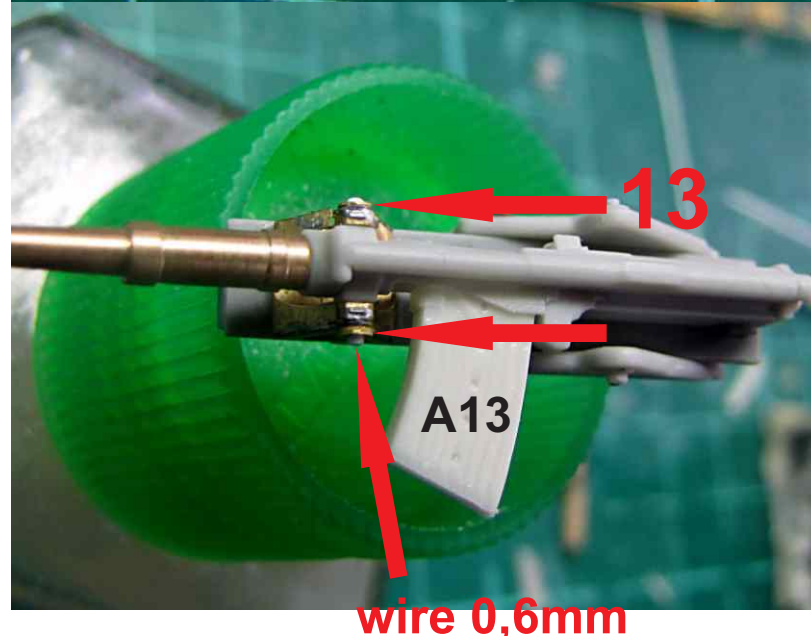
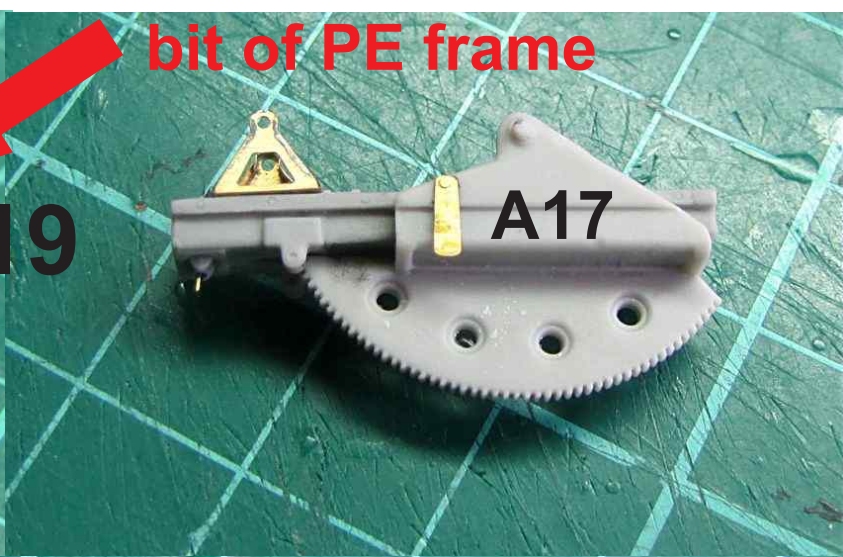
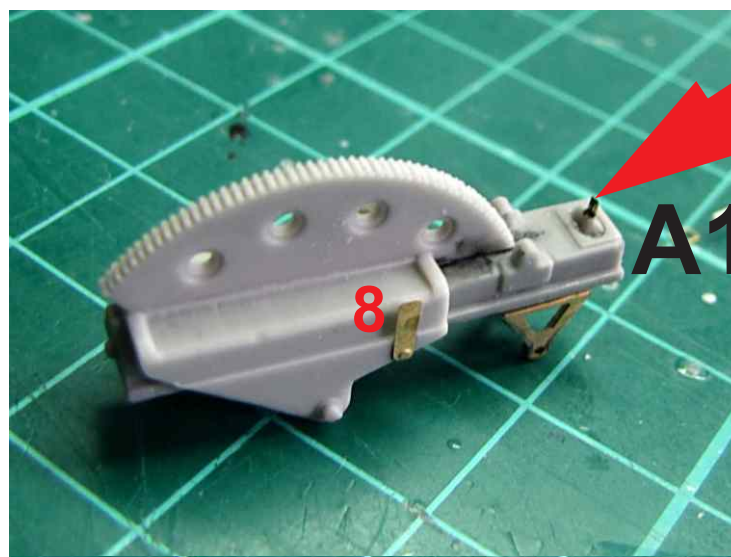

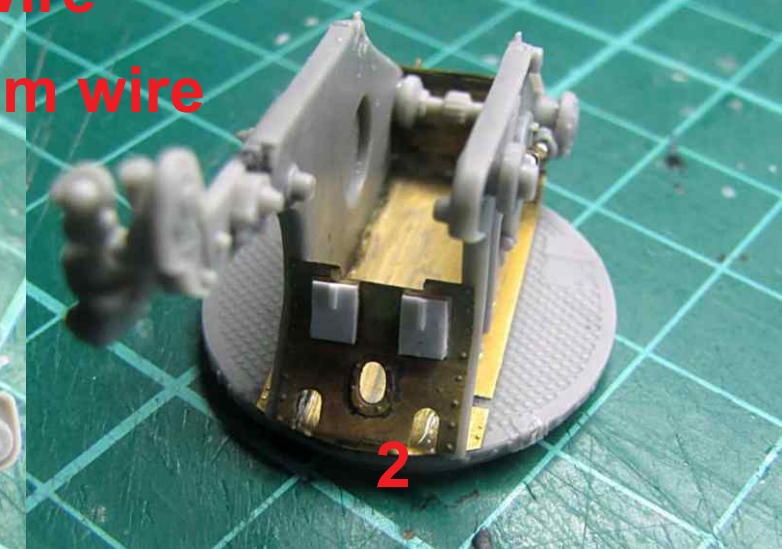

wire 0,8mm, 18mm long

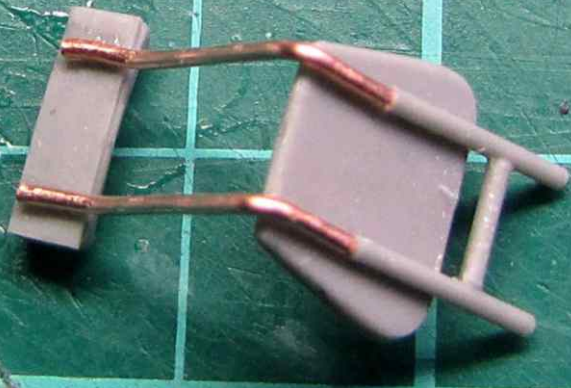
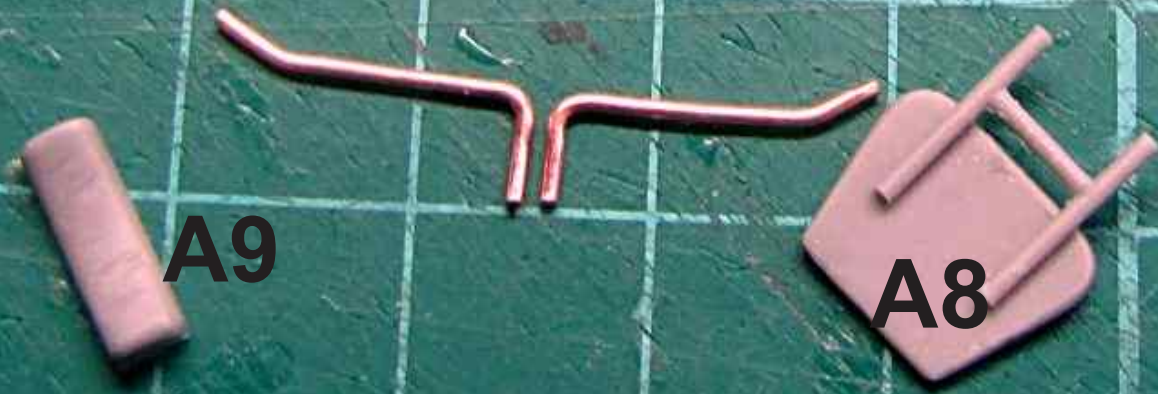

15



6

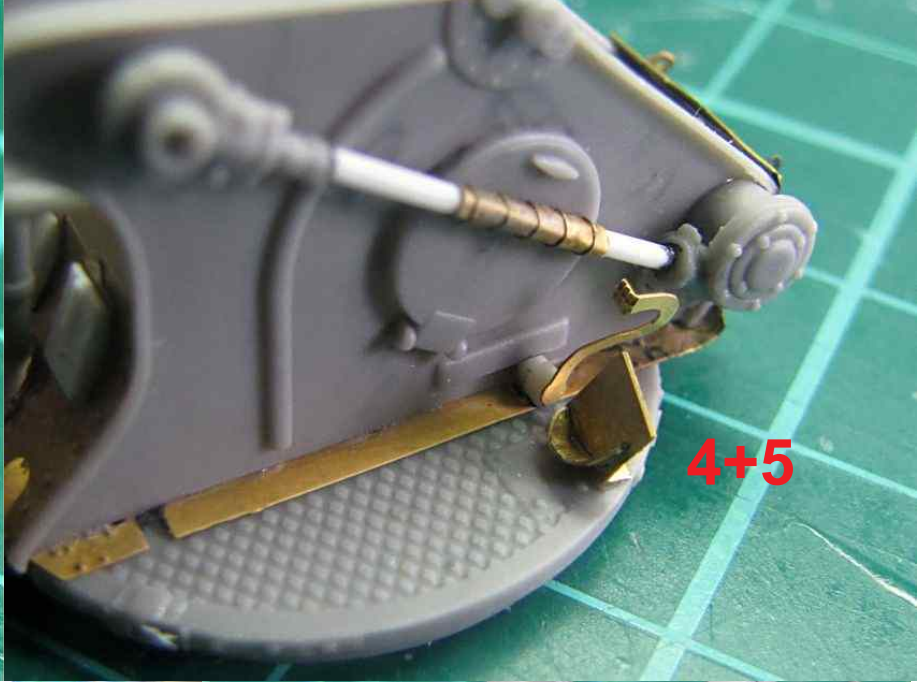
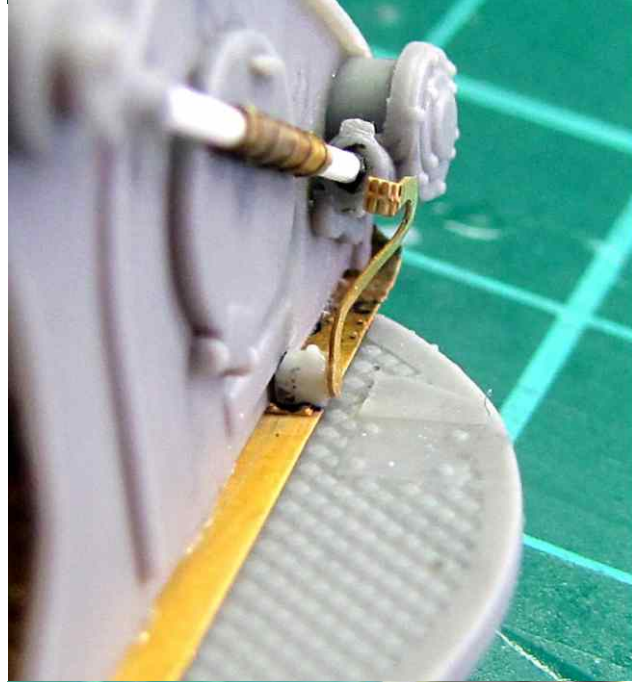
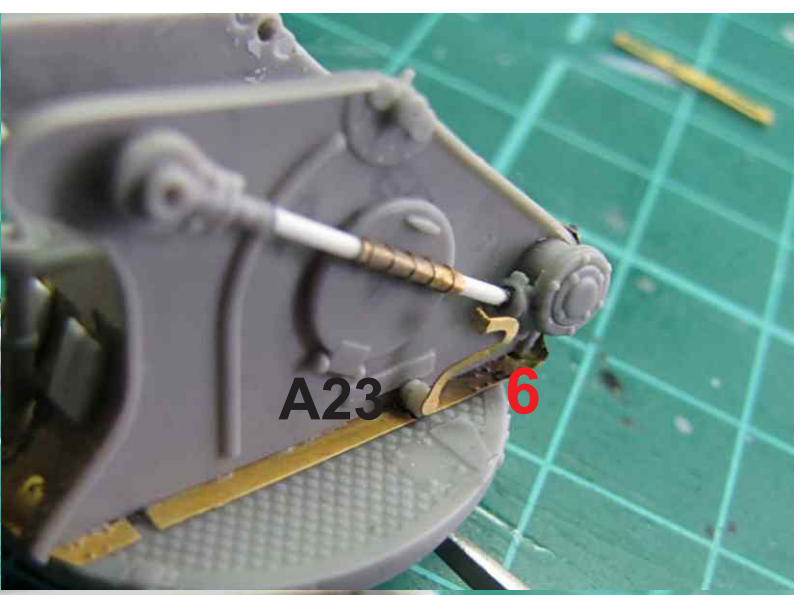
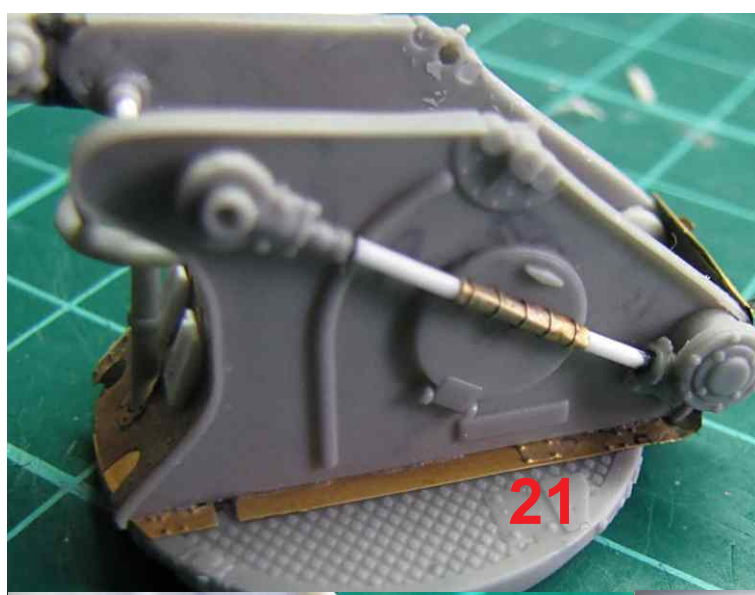

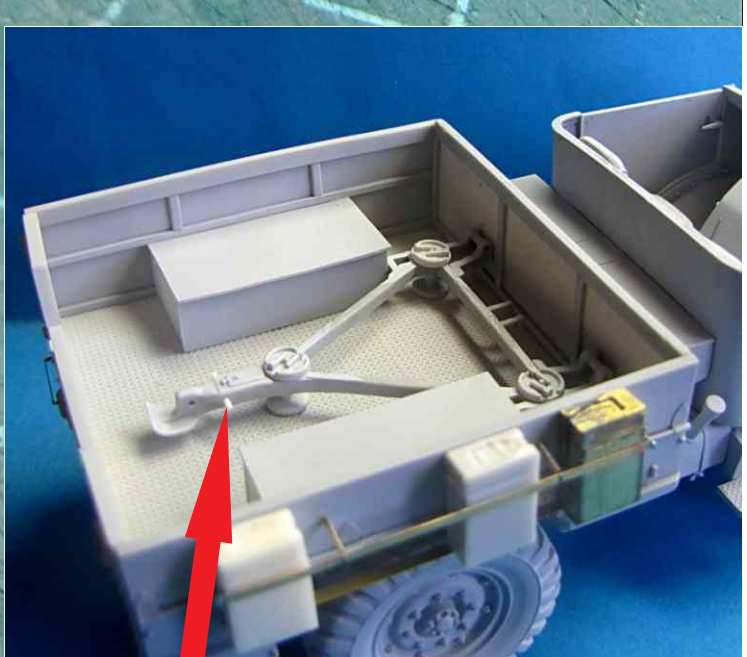
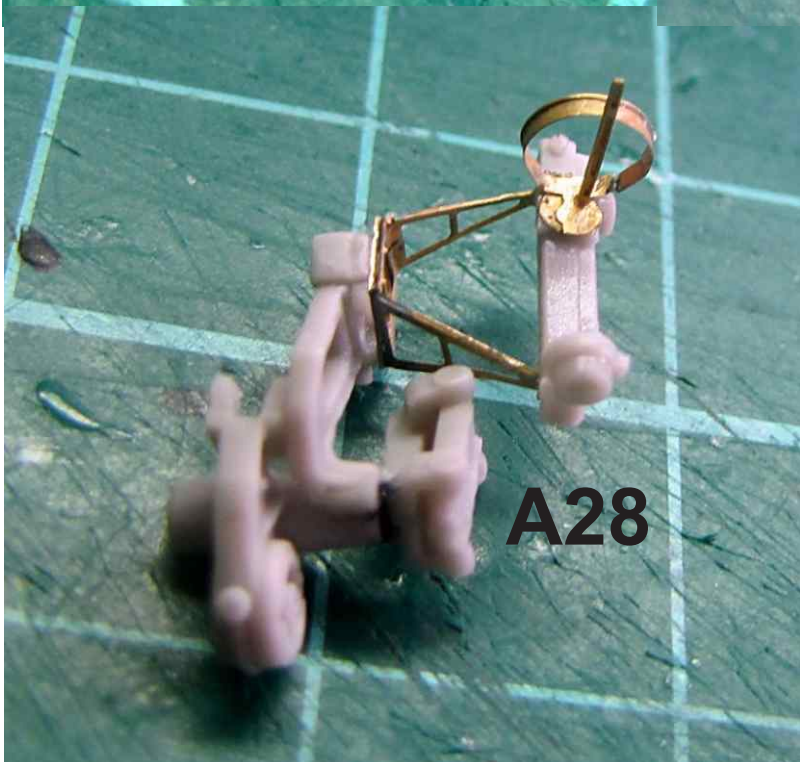
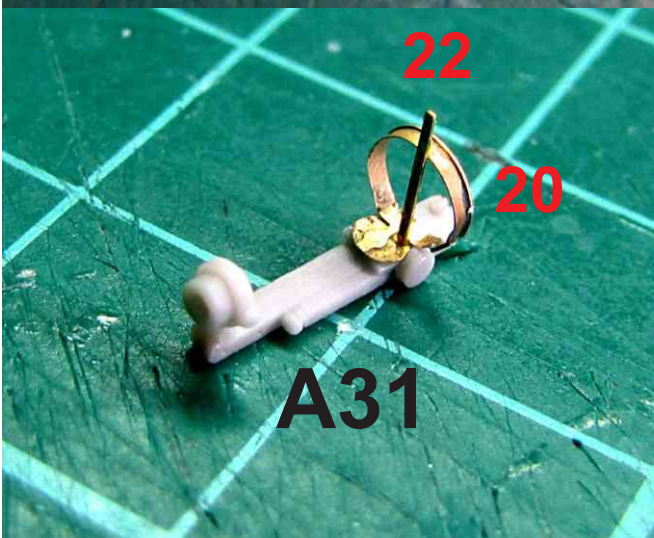
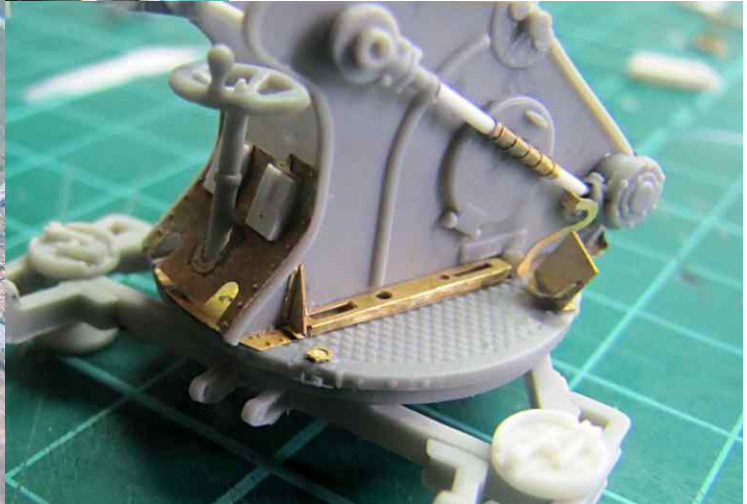
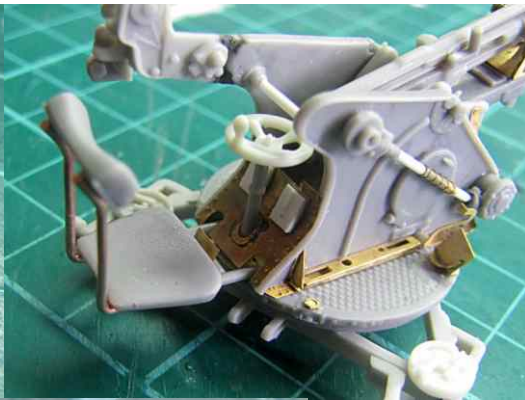

wire 0,6mm

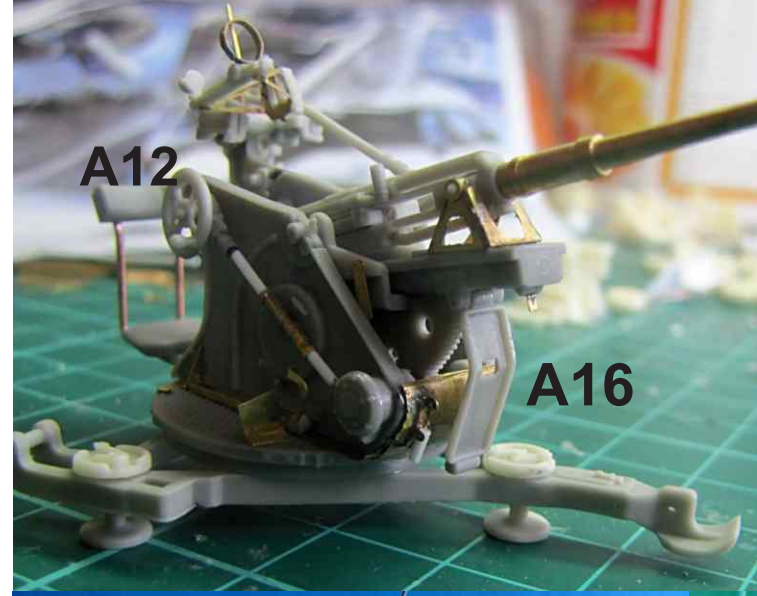
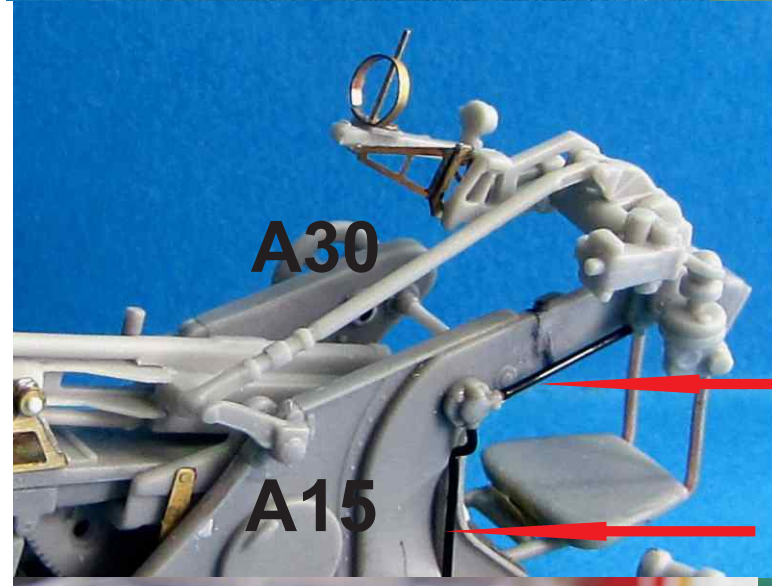
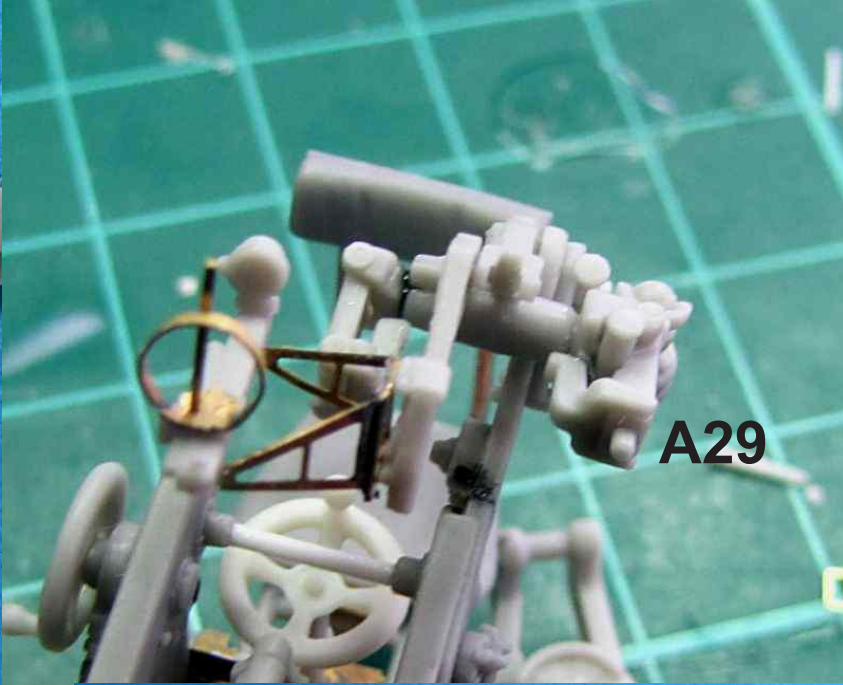
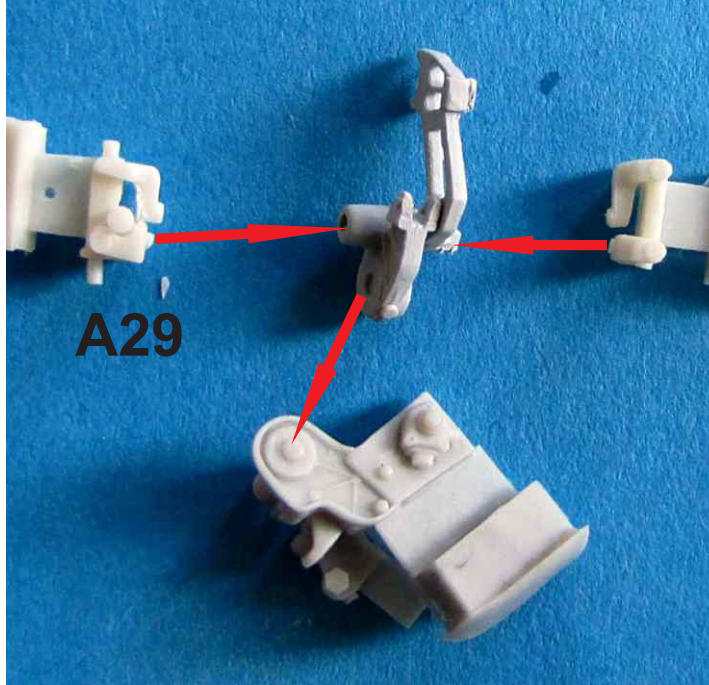

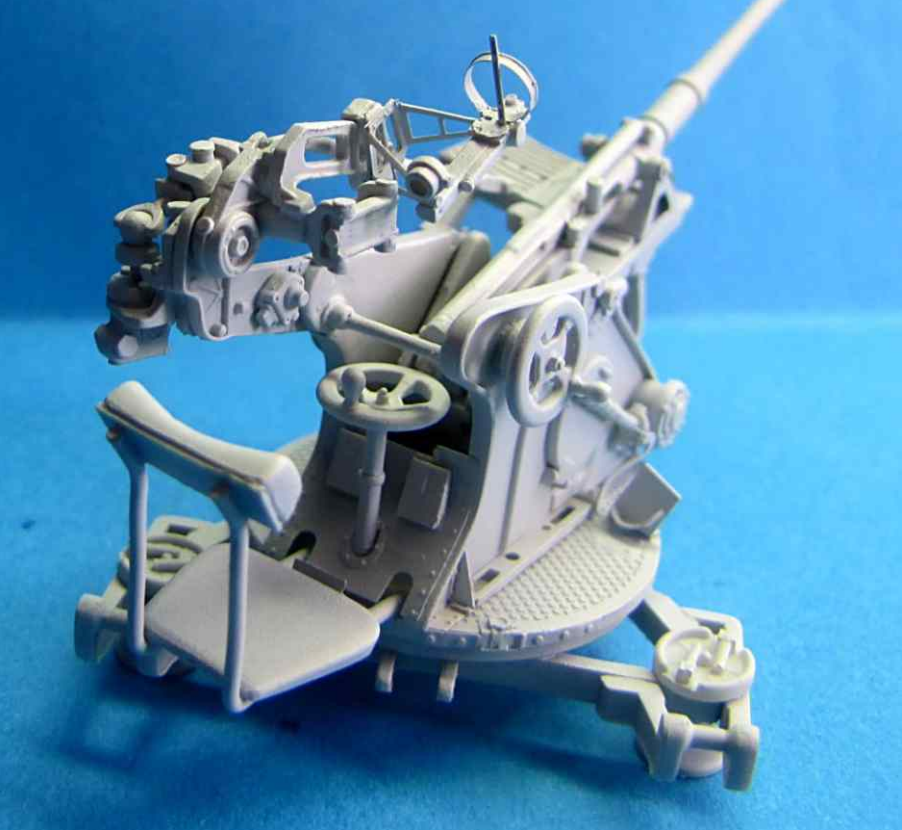

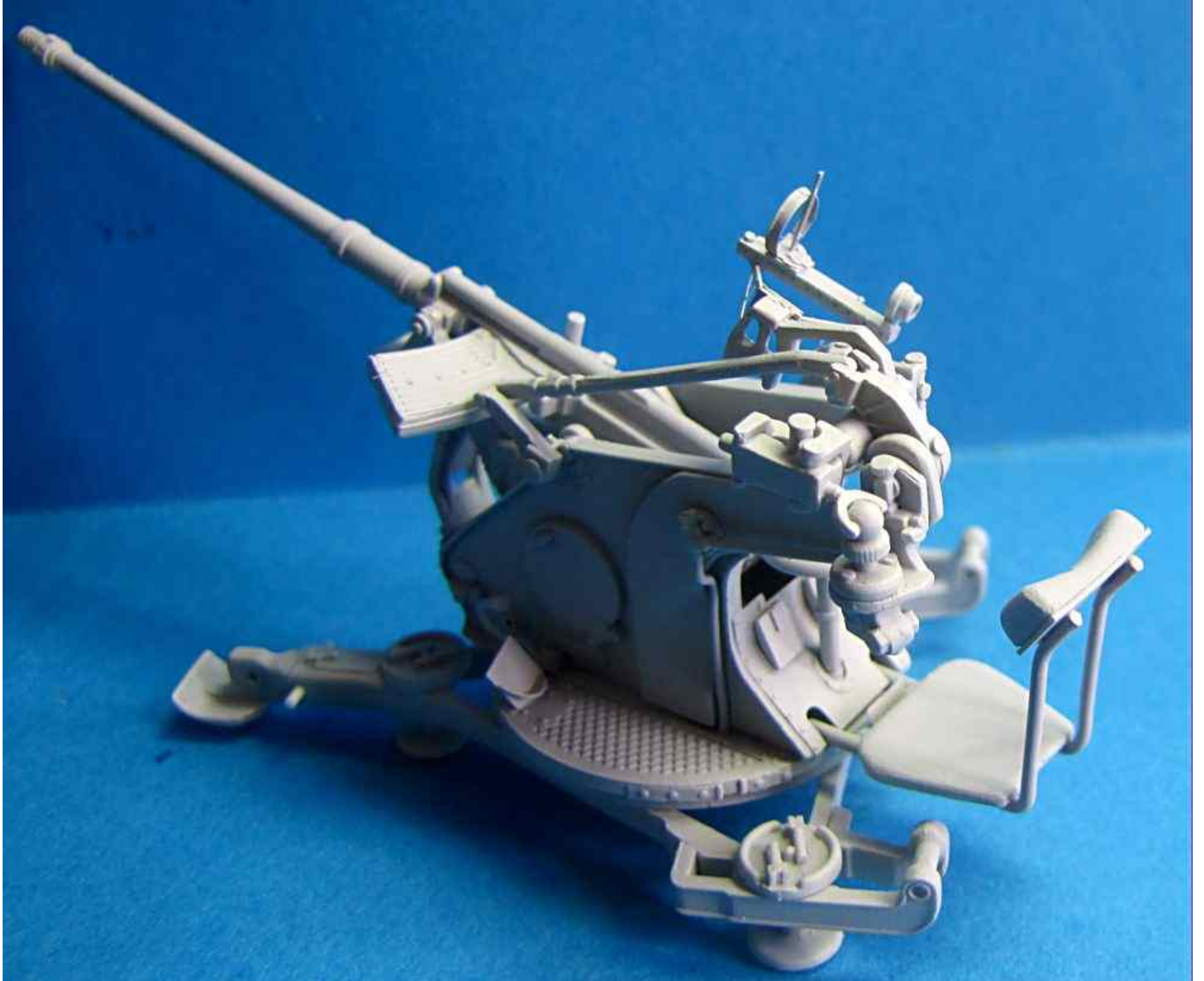
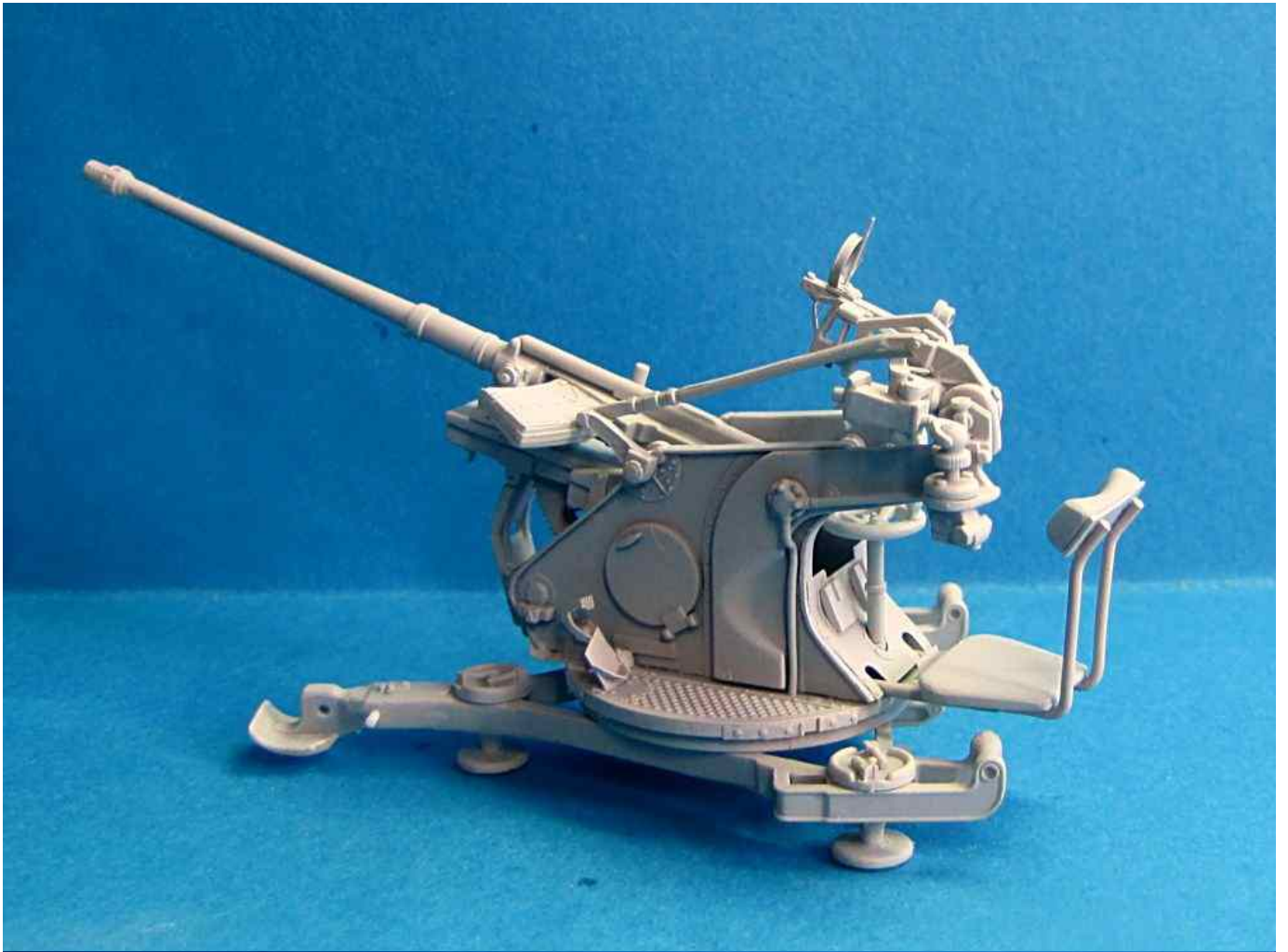

Handy website:

<http://www.german.o5m6.de/>

If you have any trouble with missing or damaged part, contact us directly at: Lzmodels.contact@gmail.com